



Owners and
operators of all
MAN B&W
two-stroke
marine engines



0.50% S fuel operation 2020

MAN Energy Solutions
Future in the making

Detailed information on fuels
with less than 0.50% sulphur
– preparation and operation

Future in the making

Contents

1. Introduction **05**
2. Regulations and standards for marine fuels **07**
3. Fuel definitions **09**
4. Solutions for 0.50% sulphur compliance **10**
5. Fuel purchasing – responsibilities and action **12**
6. Ship implementation plan **13**
7. Specification of marine fuels: ISO 8217 **17**
8. 0.50% S VLSFO characteristics **19**
9. Fuel viscosity **23**
10. Fuel pump pressure **27**
11. Fuel change-over procedures **28**
12. Lubricity **29**
13. Fuel density **30**
14. Cat fines **31**
15. Cold flow properties **32**
16. Fuel stability and fuel incompatibility **33**
17. Tank management **37**
18. Combustion characteristics – two-stroke engines **40**
19. Cylinder condition **45**
20. Fuel testing – in laboratory and in service **46**
21. Biofuel **48**
22. Fuel not fit for purpose – fuels creating problems on board **50**
23. References **52**

This paper provides detailed information and guidance on 0.50% S fuel and how to prepare for the change from engine operation on high-sulphur fuel to 0.50% S fuel. It includes directions on what to pay attention to concerning the fuel properties and how the fuels affect the equipment on board. Expectations for the new types of fuels are also given.

1. Introduction

On 1 January 2020, the global sulphur (S) limit on marine fuels will be reduced from 3.50% to 0.50% S. The decision, which has a major impact on the marine industry, was taken in 2016 at the 70th session of IMO's Marine Environment Protection Committee (MEPC 70). Operators have the following three options for operation in global waters outside emission control areas:

- operate on max. 0.50% S fuel
- operate a dual fuel engine on liquefied natural gas (LNG), liquefied ethane (LEG), methanol or liquefied petroleum gas (LPG) or
- continue operating on high sulphur heavy fuel oil (HSHFO) and apply an approved equivalent mean to reduce sulphur oxide (SOx) emissions in the exhaust, e.g. an exhaust gas scrubber.

MAN Energy Solutions (MAN ES) expects that the marine fuel market will be more differentiated after 2020. The marine fuel market will include 0 – 0.50% S petroleum-based fuel types, high-sulphur fuels for scrubber applications, LNG, LEG, methanol, LPG and various biofuels. There will be no single fuel market. MAN ES is able to provide technical solutions and guidance for all the options. However, it

is up to the owner and operator to decide which option is the most favourable. There will not be one standard solution that fits all equally well. The owner's and operator's decision is mainly governed by regulations, availability and price.

This paper gives information and guidance on max. 0.50% S fuel operation and how to prepare for the change from operation on high-sulphur fuel to 0.50% S fuel.

The potential challenges with the new 0.50% S fuels are discussed, e.g.:

- increased variation in the viscosity, density and cold flow properties from fuel batch to fuel batch, even within the same fuel grade
- instability of the fuel
- incompatibility between fuel batches
- cat fines content in the fuel



Information on the new fuel types is also given. The paper includes information on the ship implementation plan and what to consider in regard to fuel properties and equipment on board. Fuel testing and what to do when receiving a fuel not fit for purpose as well as a section on biofuel are also included. Table 1 gives a summary of the information and recommendations in this paper.

Notwithstanding the foregoing, it remains the responsibility of the owner/operator of an engine to ensure that suitable fuel is conditioned and used in order to prevent damage to the engine and other equipment on board.

Summary of the information and recommendations given in this paper

Regulations and standards for marine fuels

- Be informed about the regulations, e.g. sulphur limitations, carriage ban and flashpoint requirements.

Fuels

- Properties of the 0.50% S VLSFO will vary from batch to batch and with the same fuel grade, e.g. high to low viscosity, density and pour point.
- Stability and incompatibility should be checked for each fuel.
- Ensure that the fuel characteristics and the ship's technical capabilities are matching each other.
- Know what is bunkered. Ask for COQ (analysis of the fuel in the shore tank).
- Check the parameters of the actual fuel and act upon the results, e.g. fuel temperature adjustments.

Ship updates

- Take an informed decision regarding what 0.50% S compliance option to choose. 0.5% S VLSFO, SO_x scrubber, LNG, liquefied ethane, methanol, LPG.
- Make a Ship Implementation plan for each of the vessels and execute it. 1. Now and until 2020 and 2. Operation after 2020.

Fuel system update

- Increased fuel flexibility can be achieved by installing separate fuel lines.
- Flexible fuel system: making it easier to handle different types of fuels.
- Simple fuel system: increased attention to fuel system handling is necessary when changing fuels.
- Ensure that the viscometer before engine is installed and working properly (section 9).
- Ensure that heating and cooling equipment is installed and working properly (section 9).

Engine updates

- Install cermet coated piston rings. Refer to SL2018-659.
- Fuel pumps should be able to handle high and low viscosity fuels (section 10).

Operation recommendations

- Update operation procedures if necessary.
- Avoid fuel compatibility issues. Avoid mixing different fuel batches.
- If mixing cannot be avoided. Check compatibility (ASTM D4740 aka spot-testing or coffee filter test) of the different fuel batches.
- Fuel cleaning. Use the highest suitable temperature and lowest possible flow in the separators in order to ensure efficient cleaning and maximum removal of cat fines (sections 13 and 14).
- Be cautious when switching fuel: Monitor temperature and viscosity. Max. 2°C/min (section 11).
- Cold flow properties: Heat the fuel sufficiently above pour point, min. 10°C above (section 15).
- Fuel viscosity at engine inlet: 2-20 cSt. (section 9).
- Cylinder lubrication. Refer to the most recent lubrication guideline available for your specific engine type.

Other Guidelines

- Operation on biofuels.
- Fuel testing – in laboratory and in service.
- Fuel Not fit for purpose – fuels creating problems on board.

Table 1

2. Regulations and standards for marine fuels

This is a non-exhaustive overview of important regulations and standards for marine fuels.

IMO and ISO 8217

IMO (International Maritime Organisation) sets rules for the marine environment. Annex VI of the MARPOL convention contains regulatory requirements for fuel sulphur content and demands for fuels. The SOLAS convention includes safety requirements, e.g. minimum flashpoint for fuels.

The ISO 8217 standard specifies the requirements for fuels used in marine applications prior to conventional onboard treatment. It is a well-known document used by most fuel sellers/suppliers and fuel purchasers/users in the marine market.

The ISO 8217 is a commercial standard used in commercial agreements, while IMO sets the regulatory framework, which must be complied with.

Sulphur emission control areas

From 1 January 2020, a global limit of 0.50% sulphur in the fuel (Fig. 1) set by IMO enters into force. It means that all ships have to use fuel with maximum 0.50% sulphur or utilise an approved equivalent mean to reduce the sulphur oxides (SO_x) emitted, e.g. a SO_x scrubber. China has implemented 0.50% sulphur limit in Chinese territorial waters. The existing 0.10% Sulphur Emission Controlled Areas (SECAs) in waters around the USA and North Europe remains. Note that other regional emission areas may exist.

Carriage Ban

IMO has decided on a Carriage Ban for non-compliant fuel, which will come into force on 1 March 2020. It is only vessels with SO_x scrubbers that are allowed to carry fuel on board with sulphur content higher than 0.50% in the fuel tanks.

Dual fuel engines: Sulphur legislation requirements in pilot fuel

Dual fuel engines, depending on design, use a low flashpoint fuel (LFF): LNG, liquefied ethane (LEG), methanol or LPG, and a pilot fuel, either residual (RM) or distillate (DM) fuels. The different regulatory documents that govern the sulphur content in pilot fuel are from IMO, the European Union (EU) in Europe and the Emission Protection Agency (EPA) in the USA.

According to the legislation, it is not allowed to mix, e.g. a high-sulphur fuel and a low-sulphur fuel on board or in the engine in order to obtain certain fuel sulphur content to meet the limits. For dual fuel engines, which use LFFs and pilot fuel, this means that both fuels have to comply with the sulphur limit, even though the amount of pilot fuel is small. If the vessel is using an exhaust gas scrubber, it is possible to utilise a fuel with a sulphur content higher than the maximum limits: 0.50% S and 0.10% S.



Fig. 1 A: World map. The IMO max. 0.50 % S limit applies globally (light blue). The max. 0.10% SECA is marked as dark blue and Chinese 0.50% S limit area in orange. B: Zoom of Chinese 0.50% S limit area.

The IMO MARPOL Annex VI Regulation 4 Equivalent states that any fitting, material, appliance, or apparatus to be fitted on a ship, or procedures, alternative fuel oils, or compliance methods used as an alternative to that required by Annex VI could be approved as an equivalent means, provided they are shown to be at least as effective in emission reduction as required by a compliant fuel.

An exhaust gas scrubber is an example of an approved Equivalent means to remove SO_x in the exhaust, provided it has been tested and approved by the authorities. During scrubber operation the SO_x and CO₂ levels in the exhaust are measured and logged continuously.

Currently, there is no approved equivalent means that comply with IMO Regulation 4 with regard to dual fuel engines and pilot fuel. Accordingly,

compliance can only be obtained by utilising the operating modes described in Table 2.

Flash point requirements

The flash point limit of marine fuels is minimum 60°C in International Convention for Safety at Life at Sea (SOLAS) and in ISO 8217. SOLAS is part of IMO. According to the SOLAS convention, ships shall not use a fuel with a flashpoint lower than 60°C, unless the ship is covered by the exemptions to SOLAS Chapter II-2, regulation 2.2.2 or complies with the IGF-code. Non-compliance with the flashpoint requirements will be a serious violation of the SOLAS convention. A ship carrying and/or using fuel not complying with the flashpoint requirements may risk losing its insurance in case a fuel related accident occurs on board the ship.

ECA – max. 0.10% S ME-GI and ME-LGI engines

Option 1	Low-flashpoint fuel + max. 0.10% S ULSFO (RM or DM)
Option 2	Max. 0.10% ULSFO (RM or DM)
Option 3	Low-flashpoint fuel + scrubber + HSHFO
Option 4	Scrubber + HSHFO

IMO 2020 – max 0.50% S ME-GI and ME-LGI engines:

Option 1	Low-flashpoint fuel + max. 0.50% S VLSFO (RM or DM)
Option 2	Max. 0.50% VLSFO (RM or DM)
Option 3	Low-flashpoint fuel + scrubber + HSHFO
Option 4	Scrubber + HSHFO

Table 2: Fuel sulphur rules for dual fuel engines: ME-GI and ME-LGI

3. Fuel definitions

The abbreviations stated in Table 3 are used throughout the document.

List of fuel definitions

Fuel	Abbreviation	Fuels with...
Distillate marine fuels	DM	As specified in ISO 8217 (e.g. DMA, DMB). The latest edition is recommended.
Residual marine fuels	RM	As specified in ISO 8217 (e.g. RMD 80, RMG 380). The latest edition is recommended.
Ultra-low-sulphur fuel oil	0.10% S ULSFO-DM	max. 0.10% S, DM types max. 0.10% S, RM types
	0.10% S ULSFO-RM	
Very-low-sulphur fuel oil	0.50% S VLSFO-DM	max. 0.50% S, DM types max. 0.50% S, RM types
	0.50% S VLSFO-RM	
High-sulphur heavy fuel oil	HSHFO	Sulphur content above 0.50%, DM and RM types. Mainly RM.

Table 3: List of fuel definitions. The nomenclature is also used by CIMAC.

4. Solutions for 0.50% sulphur compliance

Operators have the following options for complying with the 0.50% S regulation (Fig. 2):

- operate an ME or MC type engine on 0.50% S VLSFO or
- operate a dual fuel ME-GI or ME-LGI type engine on liquefied natural gas (LNG), liquefied ethane (LEG), methanol or liquefied petroleum gas (LPG) or
- continue operating on high-sulphur fuels and apply an approved equivalent mean to reduce SO_x emissions in the exhaust to the same level as achieved with compliant fuel, e.g. exhaust gas scrubber.

MAN ES is able to provide the adequate technical solutions and guidance for all the options.

The decision of which path towards compliance solution to take is not easy and there is not one optimum standard solution for everyone. This means that each company needs to take its own informed decisions, ensuring that the technical solutions fit their fleet,

specific ships, mode of operation and business model.

Factors that decide the optimum solution depend for example, on the specific vessel type, age of the vessel, engine type (main engine: ME/MC vs ME-GI/LGI), trade routes and operational profile. Very important factors that influence the choice of compliance solutions are legislative requirements, the cost of new investments and (re)building (CAPEX) and the operating cost (OPEX). The price differences between fuels and the availability, logistic possibility and sustainability are aspects that also need to be considered (Fig. 3).

Distillate – DMA (ULSFO-DM)

Distillate marine fuels, e.g. marine gas oil (MGO/DMA) with appropriate sulphur content, is one available, but most probably an expensive sulphur compliance solution in regard to OPEX,

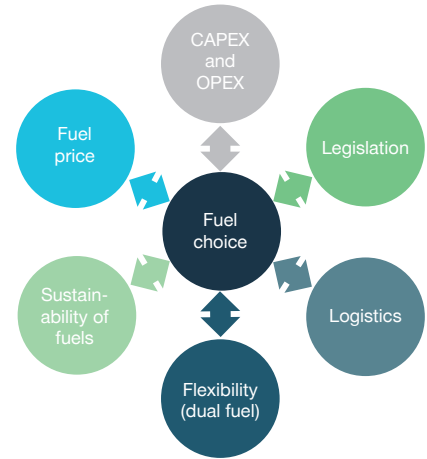

Fig. 3: Factors that influence the choice of fuel used.

due to the fuel price. DMA fuels can generally be used on all MAN B&W two-stroke engines. Guidance and recommendations are available in Service Letter SL2014-593.

Compliant fuel		High-sulphur fuel
<p>MC/ME/-C engine Single fuel: 0-0.50% S fuel</p>	<p>ME-LGI engine Dual fuel: LNG, ethane (LEG), MeOH, LPG and 0-0.50% S fuel</p>	<p>MC/ME/-C engine Diesel fuel: 0-3.50*% S fuels + scrubber</p>

Fig. 2: Fuel compliance options. *Standard engine design: max. 3.50% S fuels. Higher sulphur contents can be handled on request.

0.50% S VLSFO

Operating on 0.50% S VLSFO will probably be the most common solution. Generally, all MAN B&W two-stroke engines can operate on 0.50% S VLSFOs. The 0.50% S VLSFO family will be a mix of different types.

In 2015, when the 0.10% SECA regulation came in to force, a range of new types of 0.10% S fuels appeared, the 0.10% S ULSFO-RM. These were, and still are, a heterogeneous group of fuels, often with high pour points and supplied as RMD 80 because of this. The viscosities and densities were often within the RMB 30 limit. Much of the knowledge gained from the 0.10% S ULSFO-RM can be used as a starting point when learning how to manage the 0.50% S VLSFOs.

High-sulphur heavy fuel oil (HSHFO) and scrubbers

High-sulphur HFO (HSHFO) is traditionally a by-product from the refineries. The residual fraction is what is left when more valuable fractions of the crude oil have been extracted. These residues are used as blending stock for the blending of HSHFO. The HSHFO may change properties, as some of the fractions that traditionally went into HSHFO might now be used in other places, e.g. in the 0.50% S VLSFO. Higher viscosities, higher densities and another distribution of cat fines might be seen in future HSHFO.

Exhaust gas SO_x scrubbers can be used together with HSHFO in order to comply with the 0.50% S limit. Discussions are ongoing on whether HSHFO will be available after 2020 as the market may currently appear to be rather small, since not many ships have installed scrubbers yet. Data suggest that the larger vessels cover approx. 15% of the number of vessels, but they are responsible for approx. 50% of the fuel consumption, using the assumption that the power installed is directly related to the fuel consumption. This means that if the large vessels install scrubbers, quite a large amount of

Average sulphur content: 2.65% m/m

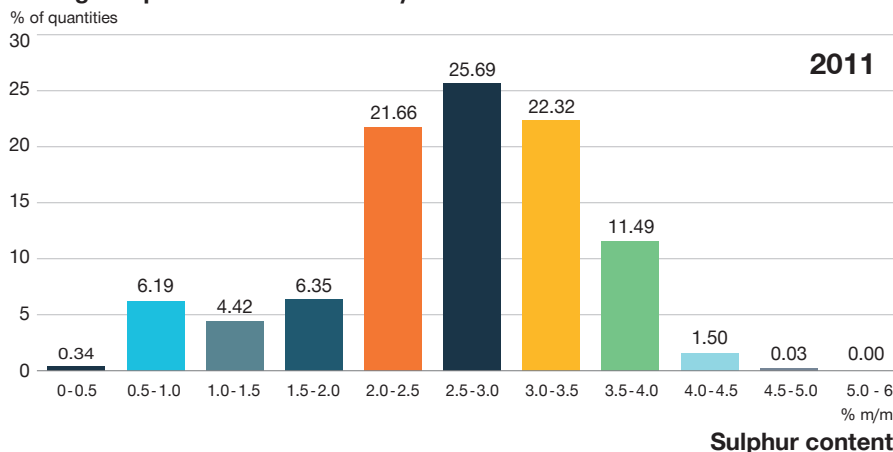

Average sulphur content: 2.60% m/m

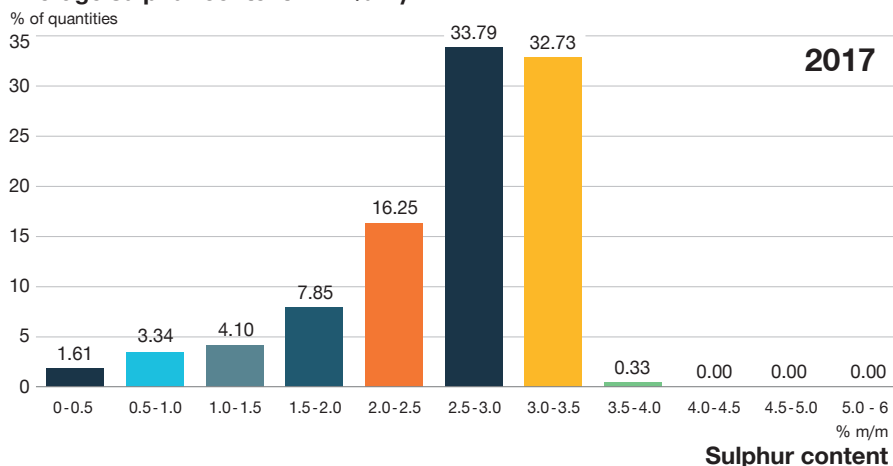

Fig. 4: IMO Sulphur monitoring programme for residual fuels. In 2011, where the global limit for sulphur in the fuel was 4.50% S, 13% of the fuels were delivered with sulphur content higher than 3.50%. Note that the average sulphur content has not changed since 2011, it remains approx. 2.6% S.

HSHFO is needed. HSHFO availability will probably be concentrated around the larger ports where most of the bunkering takes place.

It should be noted that fuels with sulphur contents above 3.50% may become available as such fuels were available before the 3.50% S limit in 2012 (Fig. 4). Scrubbers can handle fuels with high sulphur levels and scrub the exhaust down to acceptable SO_x level if they are designed and ordered for such application. MAN ES has issued SL2018-665 that deals with scrubbers. MAN B&W engine designs cover up to 3.50% S fuels, but fuels with higher sulphur content can be handled on request.

LNG, ethane, methanol and LPG – dual fuel engines

The possibility of handling different types of fuels is going to be one of the success factors in the future. Dual fuel engines, e.g. ME-GI or ME-LGI engines, are making it possible to operate on LNG, LEG, LPG and methanol. These fuels are basically sulphur free and the 0.50% S limit can easily be met. The engine can also operate on the usual ISO 8217 type of fuels. Engine technologies are available and MAN ES believes that the interest in low-flashpoint fuels as main fuel for the engine will grow at a steady pace.

5. Fuel purchasing – responsibilities and action

When fuel is purchased for a ship, there are at least three parties involved: The fuel purchaser, the fuel supplier and the operator of the ship. Each of these parties has different responsibilities and some of these responsibilities are discussed here (Fig. 5). In order to have a good process, all parties have to do their part.

Fuel supplier

The fuel supplier should deliver fuel on specification which is stable and homogenous at delivery, during long time storage, and through the fuel system in the ship, assuming that the specific fuel batch is not mixed with anything else. In other words, the fuel must be stable and homogeneous at

the supply point and up to engine inlet. The Certificate of Quality (COQ), the shore storage tank fuel specification, should be made available to the fuel purchaser and operator if this is agreed on. It is important that the fuel suppliers have adequate quality assurance and management of change procedures in place to ensure that the resultant fuel is compliant with the requirements of ISO 8217, Clause 5.

Fuel purchaser

The fuel purchaser needs to know and ensure that the fuel characteristics and the ship's technical capabilities match each other, e.g. the fuel system and engine.

Ship operator – user of the fuel

The ship operator also needs to know if the fuel characteristics and the ship's technical capabilities match each other. The operator of the ship needs to carry out procedures for tank management, fuel cleaning and handling for optimal engine performance. The operator can request the COQ if possible as the information herein will make it easier to plan and act accordingly.

Fuel buyer:

Fuel properties and ship technical capabilities must fit together

Fuel supplier:

Stability:

- during bunkering
- over time
- in the fuel system to and into the engine

Ship:

Mixing fuel on board:

DON'T MIX

Cleaning:

- separators
- filters
- Heating/cooling

Engine:

- Combustion

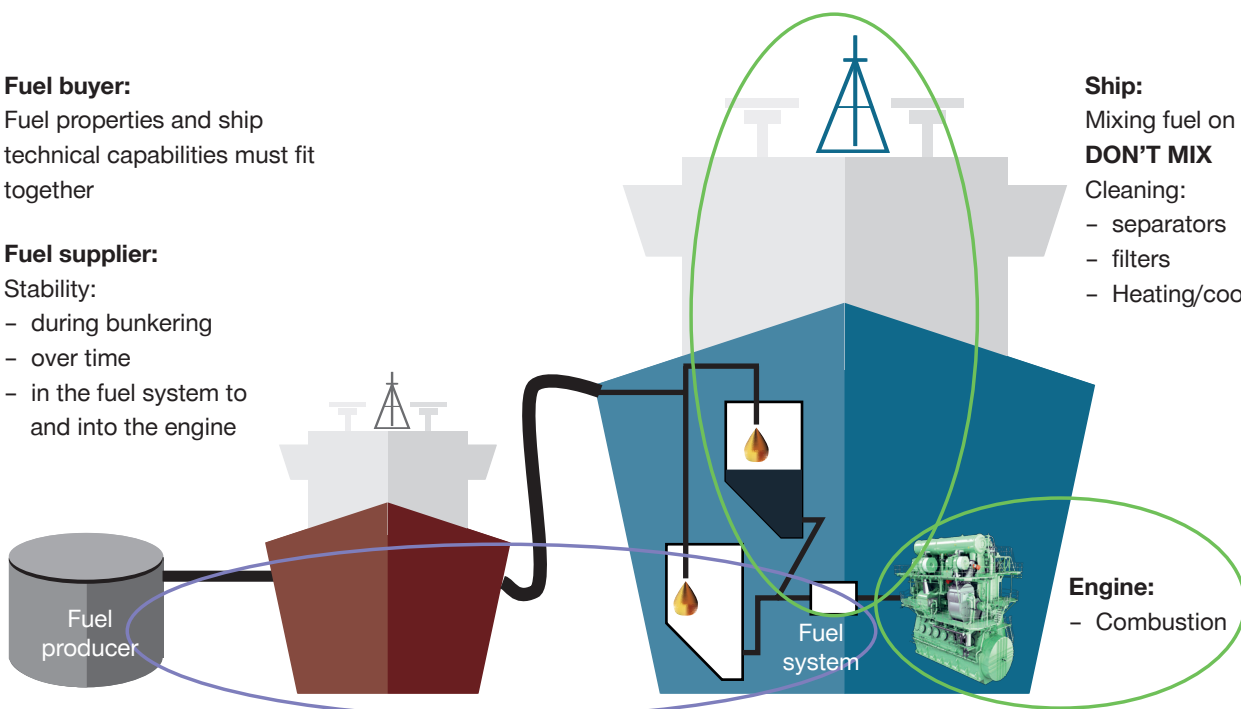

Fig. 5: Purchasing fuel. Responsibilities and actions

6. Ship implementation plan

Generally, the main goals for ship operation are: reliability, fuel supply to the engine, compliance with the regulations and the operation needs to be as economical as possible. Risks and economics must be evaluated for each ship type, route and operation pattern, and many decisions and

actions must be made to achieve the main goals.

When planning for operation on 0.50% S fuel in 2020, it is important to focus on what to prepare and do up to 2020, and on the subsequent normal operation after 2020. This must be completed as

early as possible in 2019, and the full ship change-over to 0.50% S VLSFO must be finished by 1 January 2020 at the latest (Fig. 6). IMO is encouraging the planning process up to 2020 by issuing "Guidance on the development of a ship implementation plan for the consistent implementation of the 0.50 % sulphur limit under MARPOL Annex VI" (circular MEPC.1/Circ.878).

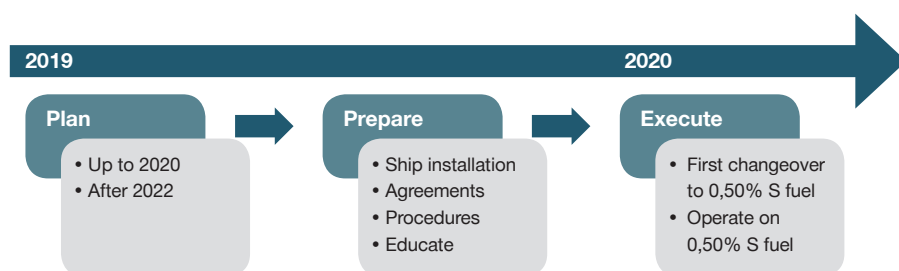

Fig. 6: Plans must be made and actions carried out. The ships must be prepared according to the plans, and the change-over to 0.50% S fuel must be executed.

Many new types of 0.50% S VLSFO will be placed on the market and this will challenge the ship installations and the handling of the fuel on board. It is important to be aware of these challenges and prepare the ships and the workforce involved in the marine fuel process. The main challenges for operation on 0.50% S VLSFO are:

1. Fuel quality will vary much more than before from batch to batch (Fig. 7).
2. Different fuel types may be incompatible, which will require that the different fuel batches must be kept segregated.
3. Important fuel parameters will vary:
 - a. Viscosity. It could vary between low (as distillate type) and high (as residual type).
 - b. Density. Density is important for fuel cleaning.
 - c. Cold flow properties. Fuel temperature must be kept sufficiently high to keep the fuel flowing freely and to be homogeneous.

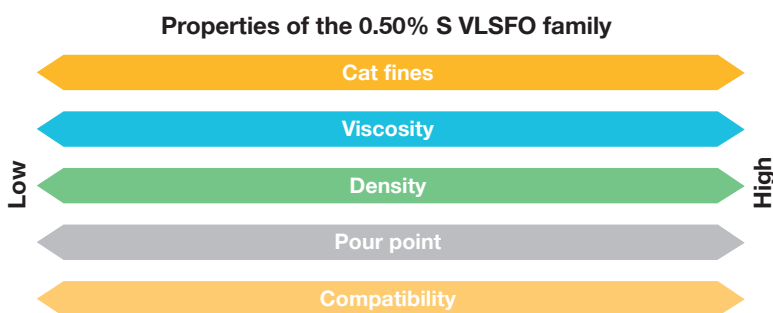

Fig. 7: The properties of the of the different fuel types in the 0.50% S VLSFO family will vary.

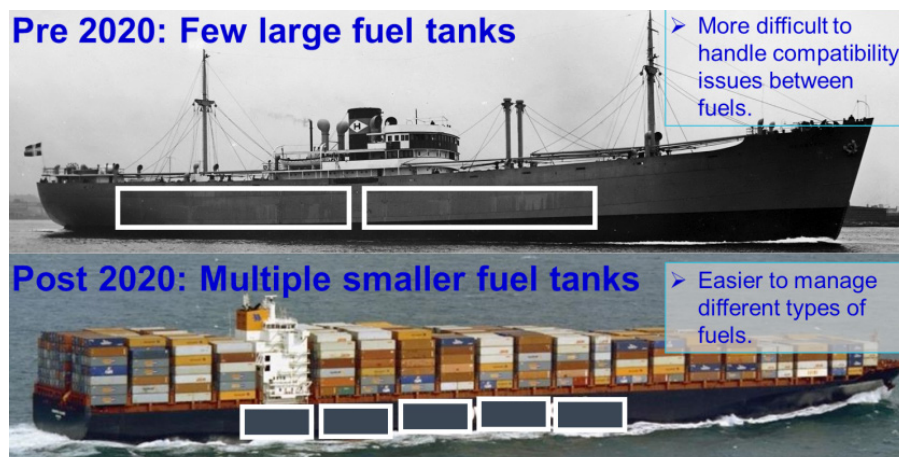

Fig. 8: Before 2020: Ships were built with few, large tanks to ease the operation on board. After 2020: Ships should be built with multiple smaller fuel tanks to facilitate segregation of different fuel batches and decrease the risk of incompatibility between fuels.

Many ships are built with few large fuel tanks. This was done to optimise the space on board and ease the operation since the fuels were often compatible. Now that we move into an era where fuel diversity is expected to increase, many fuel tanks on the ship might become advantageous. More fuel tanks means that the risk of compatibility issues decreases and managing different kind of fuels becomes easier (Fig. 8). By making an inventory of the current fleet, it could

be established what the tank situation looks like. Based on the inventory, decisions can be taken regarding whether the tank/fuel system is kept as it is or if updates are needed. For newbuilds, a flexible fuel system should be considered from the beginning in order to facilitate the management of different fuel types.

6.1 Plan for the transition up to 2020

Plans for the transition up to 2020 should be made for all ships. It should include the preparations and the installations required. MAN ES' recommendations for awareness and considerations are found below and in **Check List 1**. Recommendations and advice for operation are found in the subsequent sections.

Fuel system

Fuel quality will vary within the 0.50% S VLSFO family. Risks and economics should be evaluated when deciding on which fuel strategy to implement:

1. Flexible system – making it easier to handle different types of fuels.
2. Simple fuel system – more attention has to be paid to the fuel system handling when changing fuels.

The fuel system should be updated to cover the fuel types in the chosen strategy. It may be necessary to implement more tanks and segregated fuel systems. Installation of suitable heating and/or cooling could also be necessary to be able to handle the different types of fuel. See Section 9 Viscosity.

Fuel pump drain overflow tank

A small amount of fuel will drain through the main engine fuel pumps during normal operation. Traditionally, this fuel is led back to the heavy fuel settling tank. As the different 0.50% S VLSFO types may not be compatible, it is important to keep the different fuel streams separated. We recommend

that the drain system is updated to separate the streams. See Section 17 Tank management.

Fuel cleaning system

The existing fuel cleaning systems for high-sulphur HSHFO are generally designed for high-viscosity,

high-density fuels. Attention should be paid to whether the systems are capable of handling both high viscosity / high-density fuels as well as low-viscosity / low density fuels as these parameters may vary from batch to batch of 0.50% S VLSFO. Adequate procedures should be implemented on board to ensure that the crew is acting on the parameters of the actual fuel.

Check List 1 for preparation of the transition up to 2020:

1. Make an inventory of the fleet and decide:

- Simple vs. flexible fuel system on the ship?
- a. Different 0.50% S VLSFO fuel batches may be incompatible.
 - b. Avoid mixing different fuel batches anywhere in the fuel system.
 - c. Change/update ship systems.

2. Fuel system

- a. Fuel system may have to be updated with more fuel tanks and segregated fuel systems, and suitable heating and cooling facilities.
- b. Fuel pump drain should be managed.
- c. Ensure that the viscometer before the engine is installed and working properly.

3. Fuel cleaning system should be updated to handle both high- and low-viscosity fuels.

4. Change over from HSHFO to 0.50% S VLSFO.

- a. How to manage that the fuel at engine inlet is max. 0.50% S?
 - i. Cleaning of tanks? Storage tanks → settling tanks → service tanks.
 - ii. Removing or diluting residue in tanks?
 - iii. Decide when to change over to 0.50% S VLSFO.
- b. Sludge in tanks? Only clean and homogeneous fuel should go into the engine.
- c. Get rid of remaining HSHFO.

5. Engine:

- a. Viscosity of the 0.50% S VLSFO may vary between batches.
- b. Fuel temperature change rate must be below 2°C/min.
- c. Viscosity at engine inlet: MAN B&W: 2-20 cSt.
- d. Check if high-pressure fuel pumps are capable of operating on low-viscosity fuels.

6. Engine:

- a. Ensure that the piston rings installed are the correct ones, e.g. cermet-coated rings (SL2018-659)
- b. Cylinder lubrication: Always refer to the latest specific lubrication guideline for your engine type.
- c. Ensure that the jacket cooling water temperature is set correctly.

7. Up-date operating procedures if necessary.

Change-over from HSHFO to 0.50% S VLSFO

From 1 January 2020 the ship must comply with the 2020 regulations. This means that the engine must burn max. 0.50% S fuel, and that the fuel delivered must be with max. 0.50% S. The shipowner should make a plan and implement it, in order to be compliant by 1 January 2020. The remaining high-sulphur fuel should be used prior to 1 January 2020 or be discharged off. 0.50% S fuel should be purchased. The shipowner should evaluate how to secure that the fuel to the engine will be 0.50% S without being contaminated with the previous high-sulphur fuel causing the sulphur content to get above 0.50% S at engine inlet. The owner can choose either to clean the tanks and systems or to dilute the remaining high-sulphur fuel to compliant level. See Section 17 Tank management.

Engine preparation

The engine should be prepared to be able to handle the new types of fuel. Viscosity may vary from low distillate range to high residual range, which means that the high-pressure fuel pumps must be able to operate on fuels with varying viscosities. We recommend testing a very-low-viscosity fuel to verify whether the pumps are able to build up sufficiently high pressure. See Section 10.

When changing between fuel batches with different viscosity, it is important to keep the temperature change rate below 2°C/min. If the temperature changes faster, the fuel pumps may get stuck. See Section 11. We recommend to check the function of the viscometer, and to install such equipment if not yet present in the fuel system. See Section 9.

All piston rings should have cermet coating on the running surface to reduce the risk of scuffing. See Section 19 and SL2018-659. Concerning cylinder lubrication, we recommend beginning with 40 BN cylinder oil and

evaluating the condition continuously. See Section 19.

Procedures and education

Ship documentation should be updated, and procedures describing the new fuel strategy and the important challenges and solutions, should be made and implemented.

6.2 Plan for operation on 0.50% S VLSFO – also after 2020

This section includes a short overview of MAN ES' recommendations and advice for operation on 0.50% S VLSFO. **Check List 2** is available in the end of the section. Refer also to Section 20 Fuel testing for a guideline on how to test new fuels in the laboratory and in service.

Familiar fuel on board?

Many new types of 0.50% S VLSFO will emerge on the market and this will challenge the ship installations and the handling of the fuel on board. Failures may sometimes occur, as it did in 2018 when a number of ships experienced operation problems using residual fuels bunkered in the Houston area. When these problems occurred, it proved to be beneficial to have another fuel on board, so that the crew could switch to another fuel.

Stability of the fuel

The fuel must be stable at delivery as well as in typical ship fuel systems and in the high-pressure fuel injection equipment. See Section 16 Stability and Section 22 Fuel not fit for purpose.

Check List 2 for operation on 0.50% S VLSFO – also after 2020:

1. **It may be advisable to bring a familiar fuel on board?**
2. **Stability of the fuel**
 - a. The fuel must be stable at delivery, and in typical ship fuel systems and in the high-pressure fuel injection equipment.
3. **Compatibility between different fuel batches**
 - a. Different fuel batches may not be compatible
 - i. Avoid mixing different fuel batches.
 - ii. Maybe change over using distillate (DM) type in-between batches?
4. **Fuel characteristics may vary between fuel batches within the same grade:**

Pay attention and act upon results:

 - a. Viscosity of the fuel.
 - i. Pay attention to the fuel temperature: Use the viscometer and ensure that the viscosity at engine inlet are adequate.
 - ii. Clean the fuel at lowest flow through separators and highest possible temperature, ensuring that the viscosity at engine inlet is as required.
 - b. Density of the fuel: Use the correct gravity disc in classic separators.
 - c. Cold flow properties of the fuel: Heat the fuel sufficiently above pour point and possible wax formation point.
5. **If max. 0.50% S cannot be purchased, use the FONAR.**

Compatibility between fuel batches

Different 0.50% S VLSFO fuel batches may not be compatible, and we recommend that different fuel batches are kept segregated. If two fuel batches are very incompatible, it may be necessary to change over between the two batches using a distillate type fuel. See Section 16.

Fuel characteristics will vary between batches

Fuel characteristics may vary between fuel batches within the same grade. Some fuel suppliers can supply a Certificate of Quality (COQ) for the fuel in the shore storage tank. The COQ can be received before bunkering and the information herein will make it easier for the crew to plan and act accordingly.

Viscosity of the fuel at engine inlet should be 2-20 cSt (see Section 9), and the fuel temperature change rate must be below 2°C/min (see Section 11). Fuel cleaning should be carried out at the highest possible temperature, ensuring that the requirements for viscosity at engine inlet are fulfilled and that this is done at the lowest possible flow through the separators to enable optimal fuel cleaning.

Density of the fuel is important for the fuel cleaning. Correct size gravity discs should be used in classic separators. See Section 13.

To keep the fuel flowing freely, the fuel should be heated sufficiently above pour point and possible wax formation point. See Section 15.

Fuel Oil Non Availability Report (FONAR)

It may be difficult to purchase 0.50% S VLSFO in all ports, especially in the beginning of the 0.50% S VLSFO-era. According to MARPOL Annex VI, the ship should not be required to deviate from the intended route to bunker compliant fuel. If the ship cannot purchase compliant fuel, the ship's flag state and the next coming port state must be informed. If the ship is found to be non-compliant, the port state is entitled to require the ship to present a record of the actions taken to achieve compliance and provide evidence that it attempted to purchase compliant fuel. If the ship provides this information, the port state shall take into account all relevant circumstances and the evidence presented to determine the action to take.

IMO is currently developing guidelines for consistent implementation of the 0.50 % sulphur limit under MARPOL Annex VI. As a part of this work to standardise the information used in this process, the FONAR template is under development. It should be stressed that the FONAR is not to be considered an exemption from the sulphur regulation,

which could automatically provide freedom from punishment. The port states and flag state are expected to follow the ship's history of non-compliance and take action if it is not justified that the ship has taken all efforts to obtain compliant fuel before bunkering non-compliant fuel.

It is expected that the guidelines from IMO on consistent implementation will regard all fuels with 0.50% S or less as compliant fuel to be used globally. This includes 0.10% S ULSFO as compliant fuel for global use, and also all the different 0.50% S VLSFO types.

If the ship is not able to purchase 0.50% S VLSFO, it may have to bunker HSHFO for the next journey. When operating on HSHFO, high-BN cylinder lube oil should be used to protect the engine from cold corrosion (SL2014-587). The ship should also plan how to change back to 0.50% S VLSFO, keeping in mind that the remains in the tanks may contaminate the subsequent fuel batch with sulphur and other contaminants. The ship should plan how to get rid of excess non-compliant fuel.

7. Specification of marine fuels: ISO 8217

The ISO 8217 specification of marine fuels is a commercial standard used when purchasing marine fuels. The standard reflects and considers technical requirements, environmental and safety aspects of the fuels. It is recommended to use the latest edition of ISO 8217. The most recent edition is currently ISO 8217:2017 edition 6 and it contains important and significant changes compared to the frequently used third edition from 2005, e.g.:

- Minimum viscosity requirement for distillate grades: 2 cSt at 40°C.
- Cat fines (Al+Si) limit reduced to 60 ppm.
- Ash limit reduced.
- CCAI limits included for residual grades.
- Residual grades added/removed and expanded.
- New grades with FAME up to 7% allowed.
- Clause 5, General requirements, is revised extensively.
- Cold flow properties included for distillate grades, for information as reported.

How a fuel is assigned to a specific ISO 8217 grade

ISO 8217:2017 includes 7 distillate (DM) grades (e.g. DMA) in Table 1, and 11 residual grades (e.g. RMG 380) in Table 2. These tables state different characteristics of fuels and the corresponding limit values. When a fuel is assigned to a specific grade, then the fuel fulfils all the characteristics in that specific grade. If one of the characteristics is not fulfilled, the fuel has to be assigned to another grade.

0.10% S ULSFO-RMs are examples of

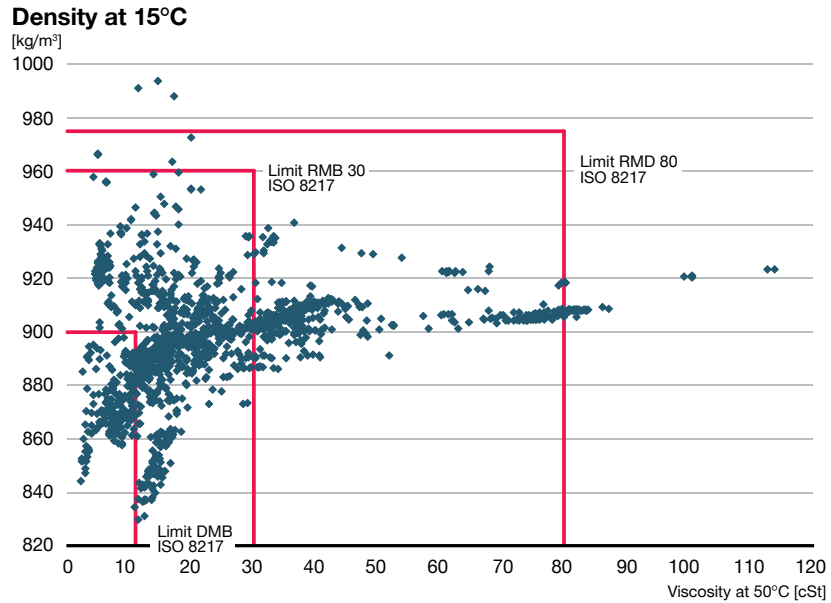

Fig. 9: Density, kg/m³ at 15°C and viscosity, cSt at 50°C of 0.10% S ULSFO-RM supplied in 2015-2016. Data: LR FOBAS. Interpretation and evaluation: MAN ES

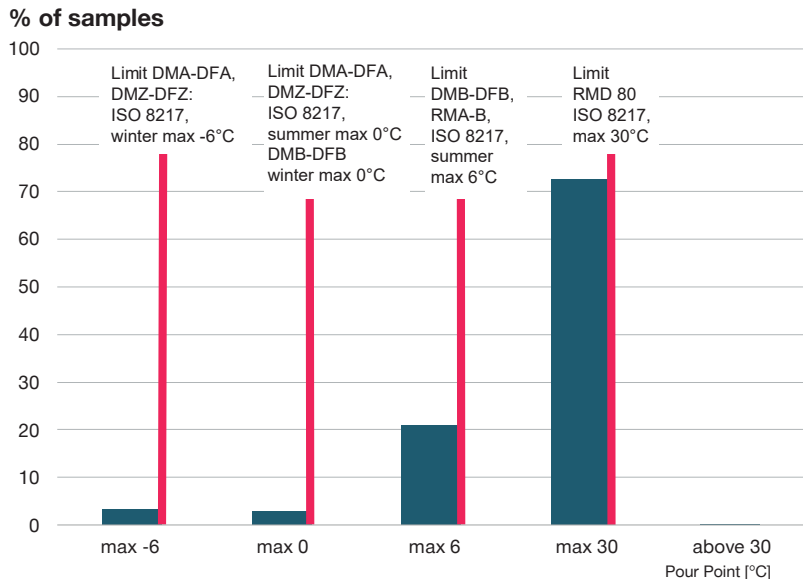

Fig. 10: Distribution of pour points of 0.10% S ULSFO-RM supplied in 2015-2016. Data: LR FOBAS. Interpretation and evaluation: MAN ES.

such fuels. A case study made by MAN ES based on data supplied by Lloyd's Register FOBAS (LR FOBAS) showed that the majority of the ULSFO-RM could have been supplied as RMB 30, if only density and viscosity were taken into consideration (Fig. 9). However, 80% of the fuels were supplied as

RMD 80, and investigations showed that the pour point is one of the determining factors for ULSFO-RM. Over 70% of the fuel samples have pour points above 6°C and hence cannot be classified as RMB 30, but have to move up to the next grade, RMD 80 (Fig. 10).

Generally, fuels are blended in order to be as close as possible to the limit of both density and viscosity in a specific ISO grade. For 0.10% S ULSFO-RM, this is not the case, which means that the operator has to be more observant of the properties of the fuel bunkered. In the 0.50% S era, the sulphur content of the different streams will also become an important blending factor apart from density and viscosity. The 0.50% S VLSFOs may also be categorised in the tables of ISO 8217 if they fulfil the characteristics in one of the grades.

ISO/PAS 23263 – Publicly Available Specification

The ISO 8217 working group is preparing a Publicly Available Specification (PAS): ISO/PAS 23263: “Considerations for fuel suppliers and users regarding marine fuel quality considering the implementation of maximum 0.50% S in 2020”. The expected publication date is in the third quarter of 2019.

The ISO/PAS will provide guidance to the application of the current ISO 8217 standard to 0.50% S VLSFO, and it is expected that the 0.50% S VLSFO types will be fully capable of being categorised within the existing ISO 8217 standard. The ISO/PAS is not expected to include new grades. Properties that will be considered in more detail will be viscosity, cold flow properties, stability, compatibility and cat fines. The ISO/PAS is an interim solution and experience with 0.50% S VLSFO will be considered for the revision of ISO 8217 after 1 January 2020. MAN ES is part of the ISO 8217 working group and preparing the ISO/PAS.

8. 0.50% S VLSFO characteristics

The max. 0.50% S VLSFO family will be a range of distillate and residual types of fuels. They will originate from sweet crudes, de-sulphurised fractions, cracked fractions, heavy and lighter hydro-treated fractions and residual fuels blended down with distillates to meet the sulphur limit, etc (Fig. 11). Examples of fuel characteristics that will vary within the 0.50% S VLSFO family are viscosity, density, pour point and cat fine (Al+Si) content. These are all important to consider since they impact many of the systems on board.

It is expected that the 0.50% S VLSFO types will be fully capable of being categorised within the existing ISO

8217 standard. MAN ES expects that fuels having characteristics within the ISO 8217 standard are well-suited for MAN B&W two-stroke engines. It is important to read and act on the fuel suppliers' recommendations and best practice sheets to ensure safe and efficient use of the fuels.

The fuel characteristics within a certain ISO 8217 grade may vary more in the future since a variation of refinery streams will be used. Fuel characteristics may vary from supplier to supplier, from port to port, and in different parts of the world. The same supplier can deliver various kinds of fuels within the same ISO fuel grade.

In order to check the validity of our expectations, we have used fuel analysis data from Lloyd's Register FOBAS (LR FOBAS) and investigated what kind of fuels are already on the market and what properties they have. The evaluation and interpretation is made by MAN ES.

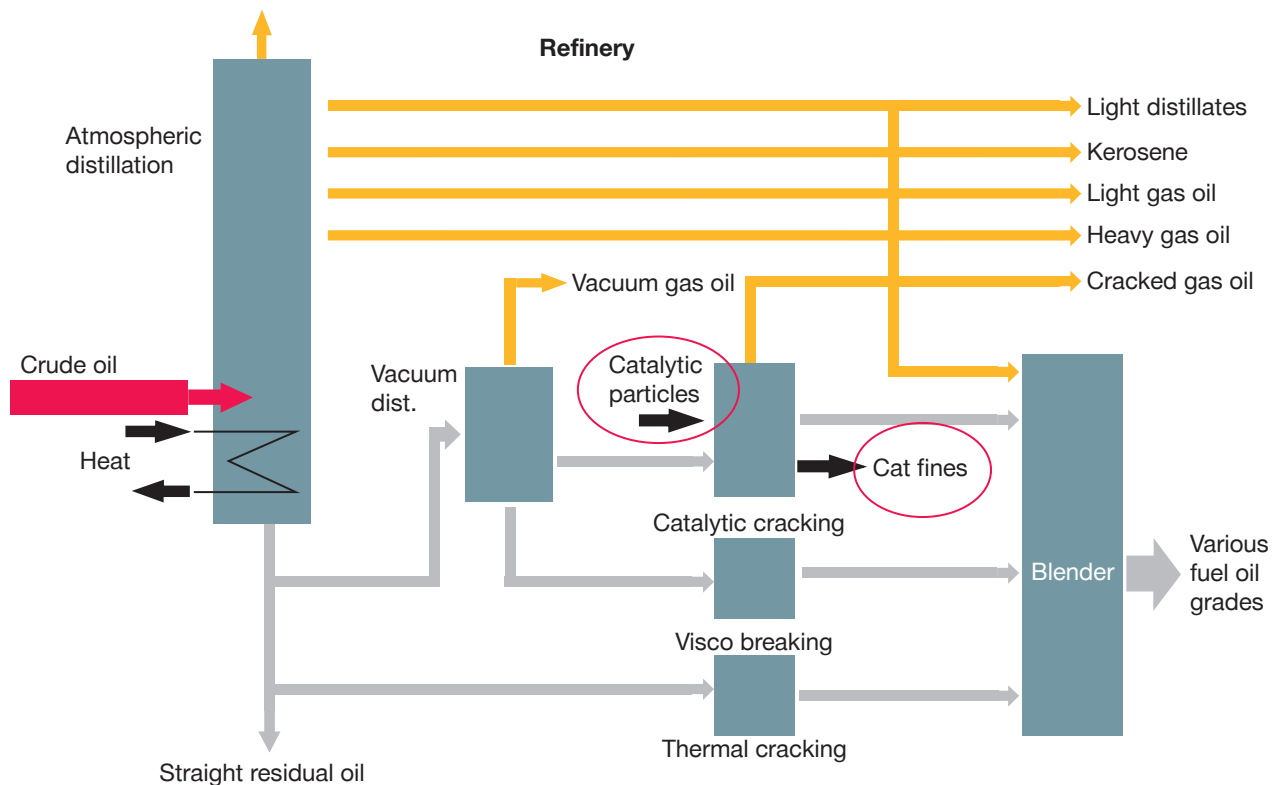

Fig. 11: Simplified schematic fig. of a refinery.

Diversity within a fuel grade

Currently, approximately 80% of marine fuels are supplied as the fuel ISO grade RMG 380. Data from this grade was used to study the variation of viscosity and density within a grade. In Figs 12 and 13 the viscosity and density distributions within the RMG 380 grade are shown.

A large majority of the RMG 380's with S% ≥ 1.1 have viscosities and especially densities leaning up towards the max. limits of the RMG 380. For RMG 380 S% ≥ 1.1, 72% of the samples have viscosities between 320.1 and 380 cSt at 50°C and 90% have densities between 970.1 and 990 kg/m³ at 15°C. Hence, in 2017 the operator could be pretty sure that if ordering an RMG 380 fuel, it would be a fuel with a viscosity roughly around 356 cSt at 50°C and a density around 989 kg/m³ at 15°C. An RMG 380 was indeed a fuel with a viscosity close to 380 cSt. The introduction of the VLSFO may change this.

The amount of 0.50% S VLSFO was not large in the 2018-market. However, there were some which could qualify as 0.11-0.50% S VLSFO-RM fuels. Data shows that the viscosities for 0.11-0.50% S VLSFO RMG 380 fuels are more diverse and 13% of the samples actually have viscosities lower than 180 cSt (Fig. 12). The density pattern for the 0.50% S VLSFO RMG 380 is completely different compared to its high sulphur counterpart, with 100% of the samples having densities lower than 970 kg/m³ (Fig. 13).

There will be a range of fuel types, and it should be noted that different types can be equally good in quality. However, they might need to be handled differently, e.g. at different temperatures in the fuel system.

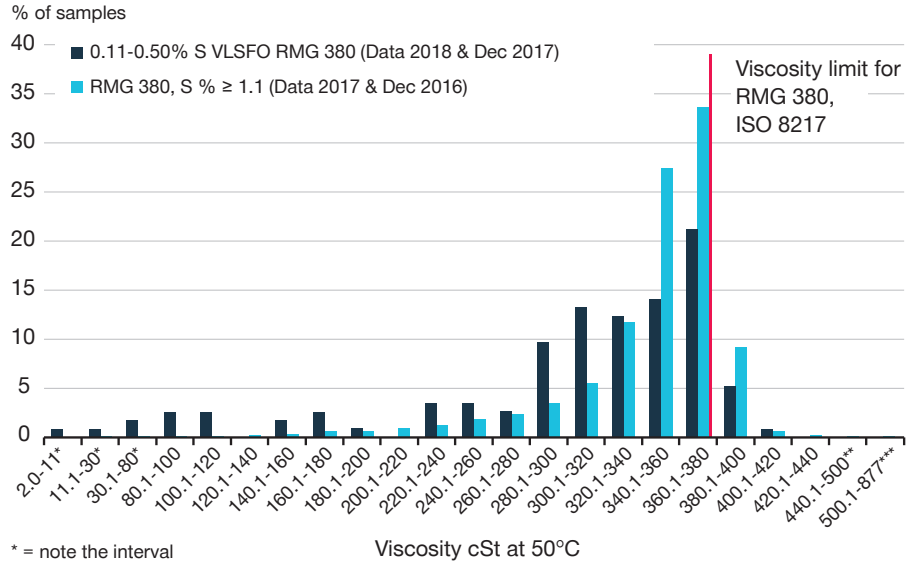

Fig. 12: Viscosity distribution of fuels supplied as RMG 380. Blue bars: RMG 380 (equal or above 1.1% S). Black bars: RMG 380 (0.11 to 0.50% S). Data: LR FOBAS. Interpretation and evaluation: MAN ES.

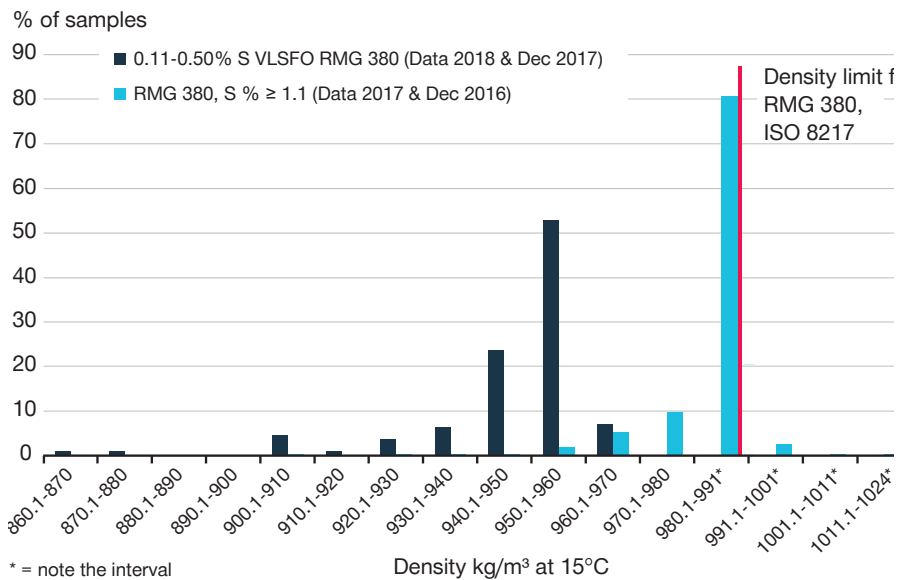

Fig. 13: Density distribution of fuels supplied as RMG 380. Blue bars: RMG 380 (equal or above 1.1% S). Black bars: RMG 380 (0.11 to 0.50% S). Data: LR FOBAS. Interpretation and evaluation: MAN ES.

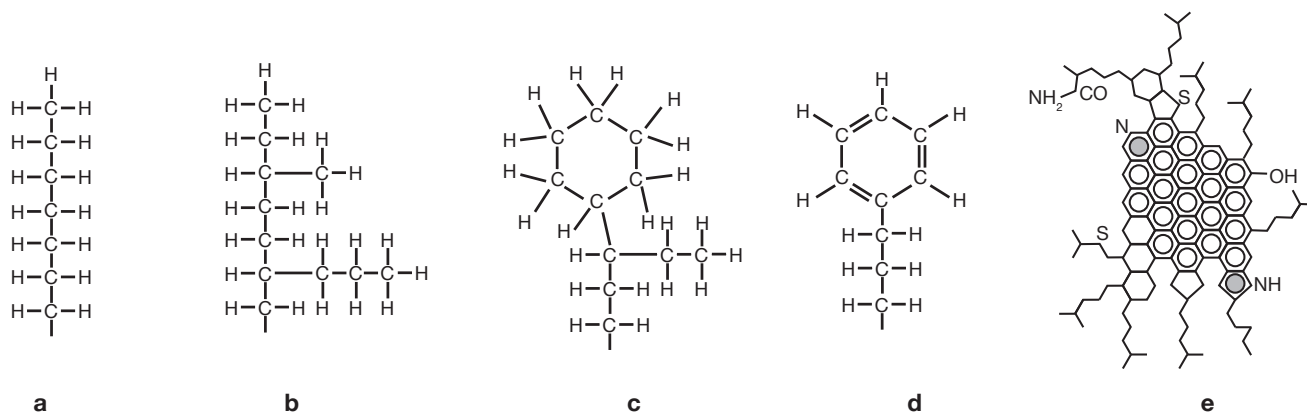

Fig. 14: Schematic pictures of (a + b) Paraffins, (c) Naphtenes (d) Aromatics and (e) Asphaltene.

Paraffines, naphthenes, aromatics and asphaltenes

Marine fuels contain a range of various molecular species. Some of these molecular species are paraffines, naphthenes, aromatics and asphaltenes (Fig. 14). The molecular species give the fuel its characteristics. Knowledge on these can give guidance on how to manage the fuel.

Some of the fuels will be paraffinic, which means long saturated hydrocarbons chains (alkanes). Paraffin has a general formula of C_nH_{2n+2} (Fig. 14 (a+b)). These have excellent combustion properties due to the favourable carbon to hydrogen ratio, but may have high pour points. Paraffins have difficulties to keep aromatic and asphaltenic molecules in suspension. This means that one should not commingle paraffinic fuels with aromatic fuel or fuels with high asphaltene content because of the high risk of precipitation of asphaltenes which results in sludge.

Saturated hydrocarbons can also be present in ring structures, e.g. cycloalkanes or naphthenes (Fig. 14 (c)). The general formula for single ring compounds is C_nH_{2n} . The naphthenes should not be mistaken with aromatics. Naphthenes have single bonds and higher hydrogen content compared to aromatics.

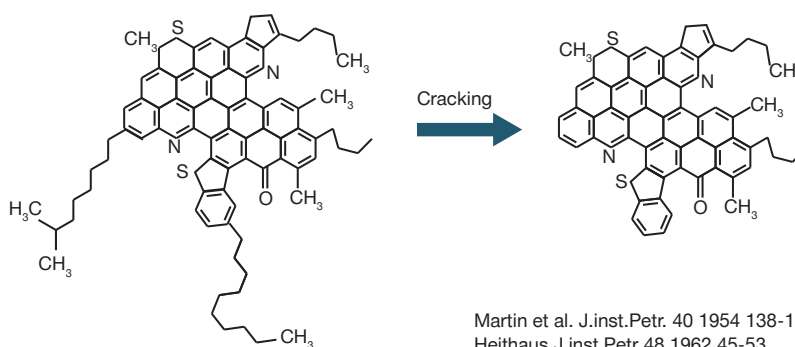

Fig. 15: Cracking changes the asphaltenes.

Aromatics (Fig. 14 (d)) are also ring structures but contain double bonds and hence less hydrogen, e.g. benzene C_6H_6 . Aromatic fuels will contain more rings structures, and presumably have a higher carbon-to-hydrogen ratio than paraffinic fuels.

Asphaltenes are large molecules containing mainly carbon and hydrogen, but also sulphur, nitrogen and some oxygen and minor amounts of vanadium and nickel and other elements. They are mainly composed of aromatic ring structures, but can also contain naphthenes and hydrocarbon chains which stick out as

arms. Aromatic fuels are considered being easier to mix with other types of fuels than paraffinic fuel types. This means that aromatic fuels potentially have less risk of asphaltenic sludge precipitation if mixed.

During cracking, the hydrocarbon chains are cut off from the asphaltene and used in other applications. The remaining aromatic ring structures formed during severe cracking will be more difficult to dissolve into various cutter stocks than the untreated molecule (Fig. 15). Stability within fuel and compatibility between fuels will be discussed in section 16.

Martin et al. J.inst.Petr. 40 1954 138-154
Heithaus J inst.Petr 48 1962 45-53

Typical fuel type characteristics

0.50% S VLSFOs will not be a specific type, it will be many different types. The characteristics of the fuel can vary from port to port and from batch to batch. Attention should be paid to the

fuel analysis and appropriate actions should be taken based on the information received. Table 4 can be used as a rough guideline to establish what kind of fuel is received. For example, if the fuel analysis states a high pour point, low to medium

viscosity and medium density, it is probably a paraffinic fuel and it will probably be difficult to mix with other fuels. In another case, if both density and viscosity are high, then the fuel is probably of the aromatic type.

Properties	General fuel data	HSHFO	VLSFO 0,50% S)	ULSFO-DM MGO	ULSFO-RM	Paraffinic type	Aromatic type
Sulphur, %	0-3.5 %	Up to: ●●●●●	●●	●	●	●●	●●
Density, kg/m ³ at 15°C	800-1010	●●●●	●●●●	●	●●	●●	●●●●●
Viscosity, cSt at 50°C	2-700	●●●●	●●●●	●	●●	●●	●●●●●
Pour point, °C	-15-+40	●●	●●	●	Up to: ●●●●	Up to: ●●●●	●●
Cat fines: Al+Si, ppm (++)	0-60-80	●●●	Up to: ●●●●	●	●●	●	Up to: ●●●●●
Combust-ability	n.a.	●●●	●●●	●●●●	●●●●	●●●●	●●
Stability	n.a.	●●●●	●●●●	●●●●	●●●●	●●●●	●●●●
Mixability (compatibility)	n.a.	●●	●●	●●	●	●	●●●

Table 4: Typical fuel type characteristics. Schematic high: ●●●●● Low: ●

9. Fuel viscosity

It is expected that the viscosity of the 0.50% S VLSFO will vary between distillate range and residual range in different batches and within the same fuel type (Fig. 16). The blue bars show data from 2017 and the striped bars show the expected, potential viscosity distribution of 0.50% S VLSFO. The expected “Percentage of samples” is more evenly distributed throughout the viscosity range for the 0.50% S VLSFO.

Fuel viscosity at engine inlet

The recommended fuel viscosity range for MAN B&W two-stroke engines at engine inlet is presented in Table 5. If the viscosity is lower than 2 cSt the fuel injection may be compromised. If the viscosity is higher than 20 cSt the fuel injection may be compromised. If the viscosity of the fuel gets too high, it will lower the effective injection pressure for the ME engines, which may lead to slower injection and lower degree of atomisation of the fuel. In the extreme, it may compromise the combustion. For MC engines, the mechanically driven fuel pumps, cams and camshaft may experience difficulties in handling the thick fuel. Temperature-viscosity relationship for fuels with different viscosity at engine inlet can be seen in Fig. 17. For those vessels not having a viscometer / viscosity sensor, it is highly recommended to install one (Fig. 20).

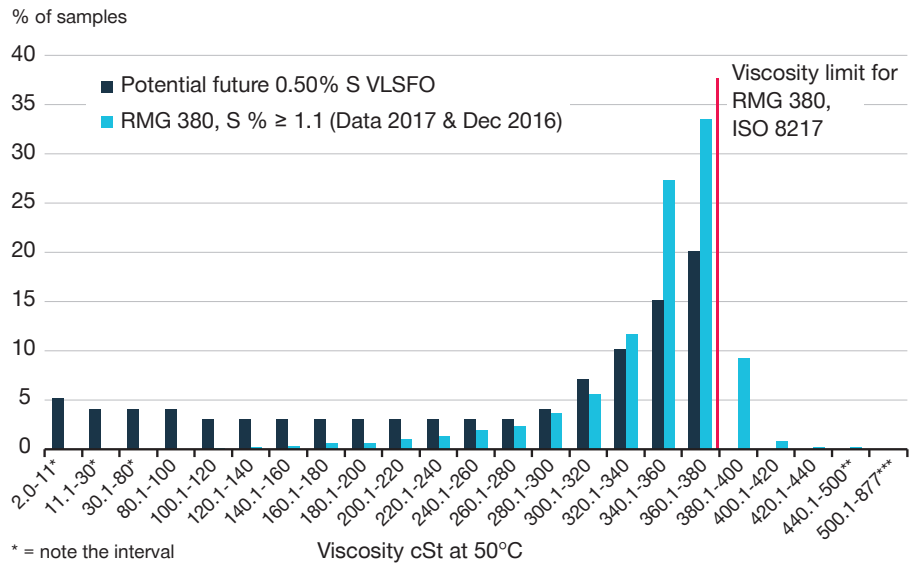

Fig. 16: Viscosity distribution for RMG 380. Blue bars: Data from 2017. Striped bars: Expected/potential viscosity distribution for 0.50% S VLSFO. Data: LR FOBAS. Interpretation & evaluation: MAN ES.

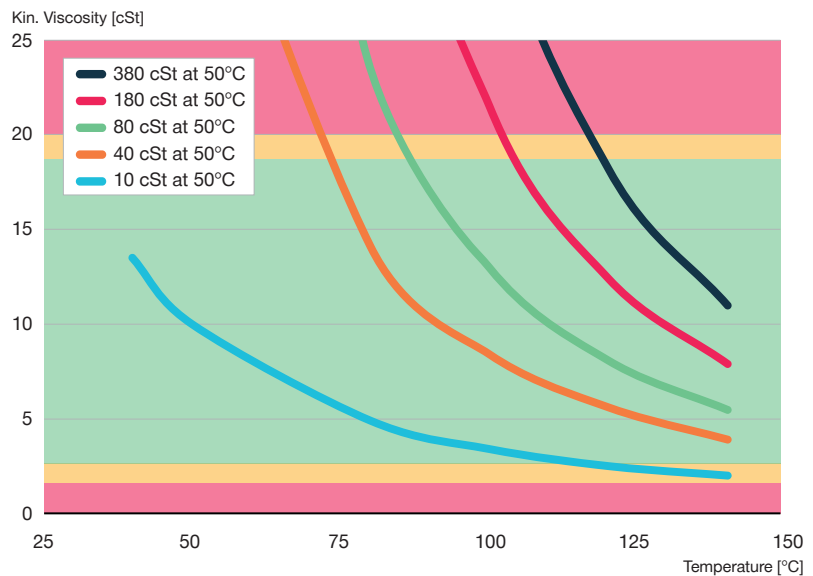

Fig. 17: Temperature-viscosity relationship for fuels with different viscosity at engine inlet.

Fuel viscosity

Range	Fuel viscosity at engine inlet
Minimum	2 cSt
Normal (DM grades)	3 cSt or higher
Normal (RM grades)	3–18 cSt
Maximum	20 cSt

Table 5: Fuel viscosity at engine inlet

Lower limit for viscosity at engine inlet: 2 cSt

The lower limit for fuel viscosity limit is 2 cSt at engine inlet. In practice, and in order to build in a safety margin against minor temperature deviations and failing viscosity controllers (viscometers), the minimum practical viscosity at engine inlet is 3 cSt. Figs 18 and 19 show typical viscosity and temperature relationships for marine fuels with very low viscosity and with medium viscosity. For low-viscosity fuels, care must be taken not to heat the fuel too much and thereby reduce the viscosity.

The external fuel systems (supply and circulating systems), depending on design and operation, have a varying effect on the heating of the fuel and, thereby, the viscosity of the fuel when it reaches engine inlet. Previously, external fuel systems on board were often designed to have an optimum operation on high-viscosity HSHFO, which means that the temperature was kept high. When running on low-viscosity fuels, the temperature of the fuel system must be as low as possible to ensure a suitable viscosity at engine inlet. Low-viscosity fuels challenge the function of the fuel pump in three ways:

1. Breakdown of the hydrodynamic oil film, which could result in seizures.
2. Insufficient injection pressure, which results in difficulties during start-up and low-load operation.
3. Insufficient fuel index margin, which limits acceleration.

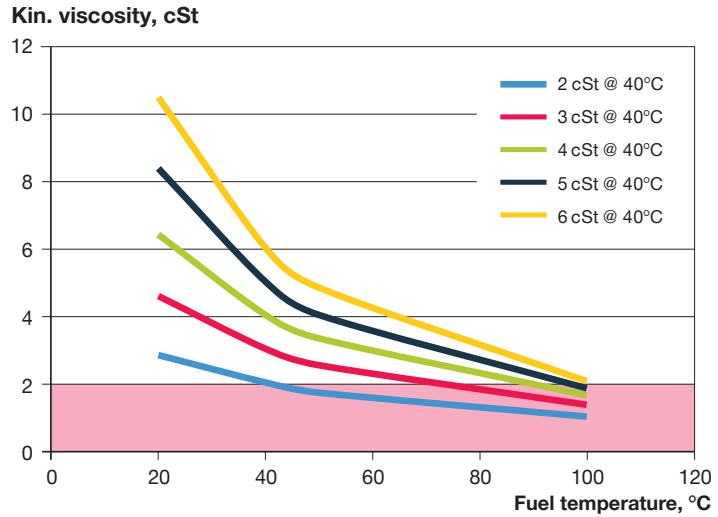

Fig. 18: Temperature–viscosity relationship for very-low-viscosity fuels.

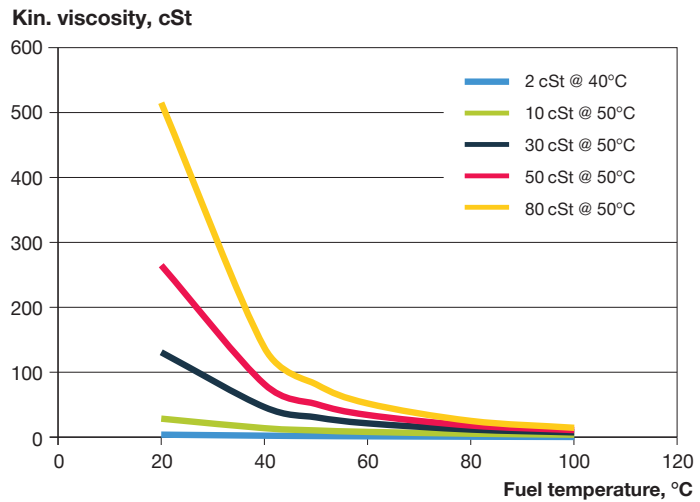

Fig. 19: Temperature-viscosity relationship for low-medium-viscosity fuels.

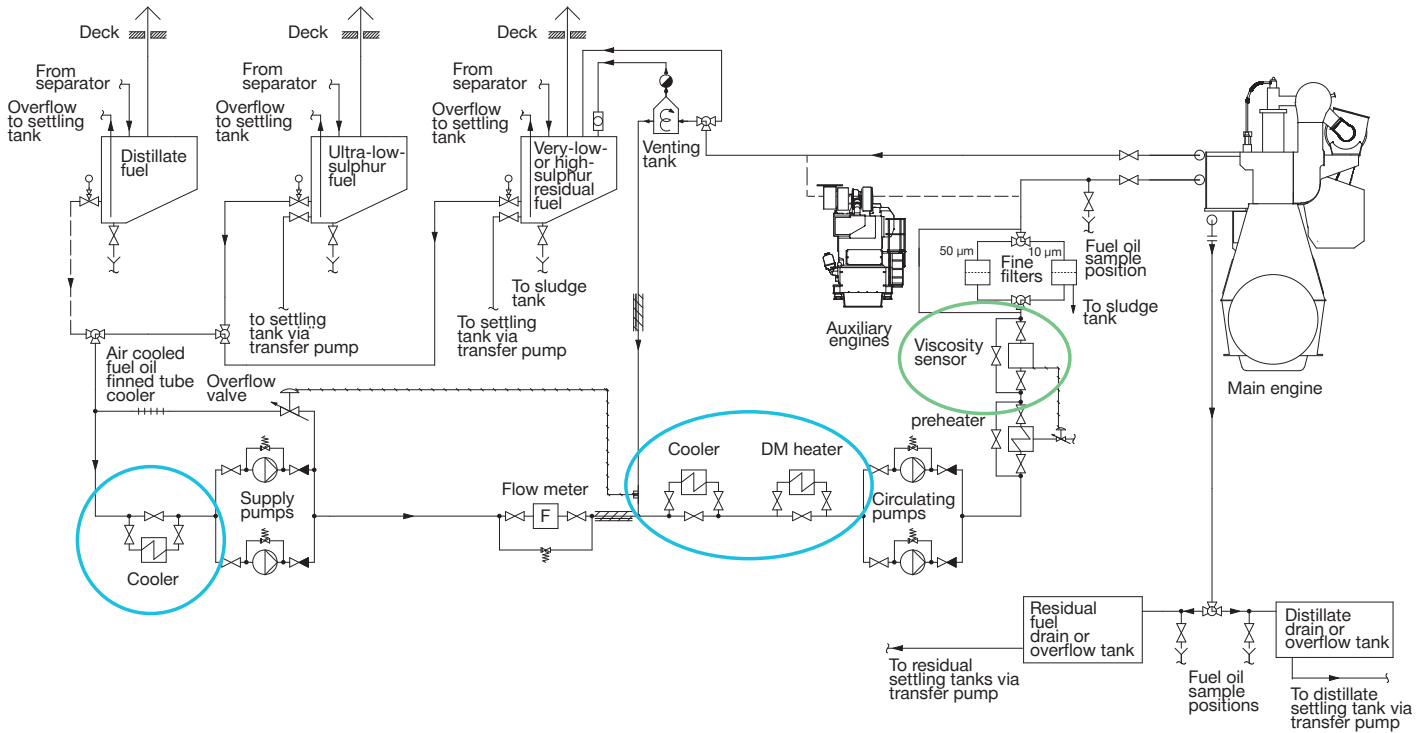

Fig. 20: Fuel system diagram. Blue circles: coolers. Green circle: viscosimeter / viscosity sensor.

Many factors influence the viscosity tolerance during start-up and low-load operation:

- Engine condition and maintenance
- Fuel pump wear
- Engine adjustment (mainly starting index)
- Actual fuel temperature in the fuel system.

Although achievable, it is difficult to optimise all of these factors at the same time. This complicates operation on fuels in the lowest end of the viscosity

range. To build in some margin for safe and reliable operation and to maintain the required viscosity at engine inlet, installation of cooler(s) may be necessary in those fuel systems which do not have these (Fig. 20).

For the very-low-viscosity distillates, a cooler may not be enough to decrease the temperature of the fuel sufficiently on board. In such a case, installation of a “chiller” is a possibility. This solution is, however, not used extensively.

The fuel viscosity is not only affecting the engine fuel pumps. Most pumps in the external system (supply pumps, circulating pumps, transfer pumps and feed pumps for the centrifuge) also need viscosities above 2 cSt to function properly. Contact the actual pump maker for advice.

Viscosity at engine inlet during change-over

As described, the viscosity of the 0.50% S VLSFO is expected to vary from low to high. If the temperature of

the fuel is not adjusted during the change-over from the previous fuel batch and the new fuel batch in order to ensure a suitable viscosity, the viscosity may increase or decrease outside the specified limits. Figs 21 and

22 show two examples of change-over between fuels with different viscosity, where the temperature of the fuel has not been adjusted, and the viscosity of the fuel ends up outside the specified limits.

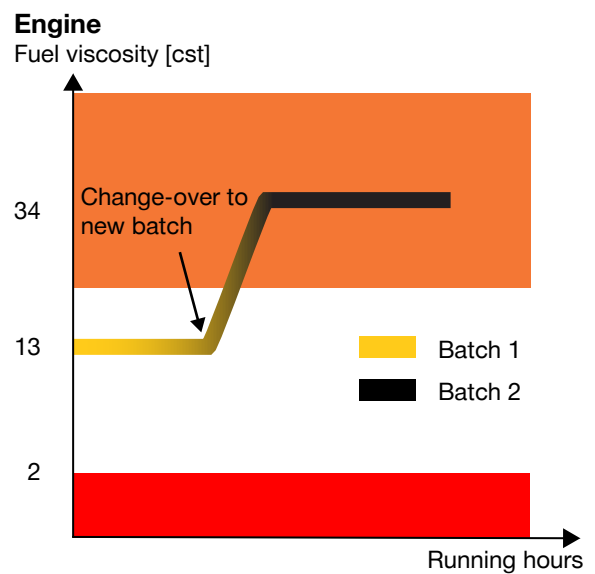
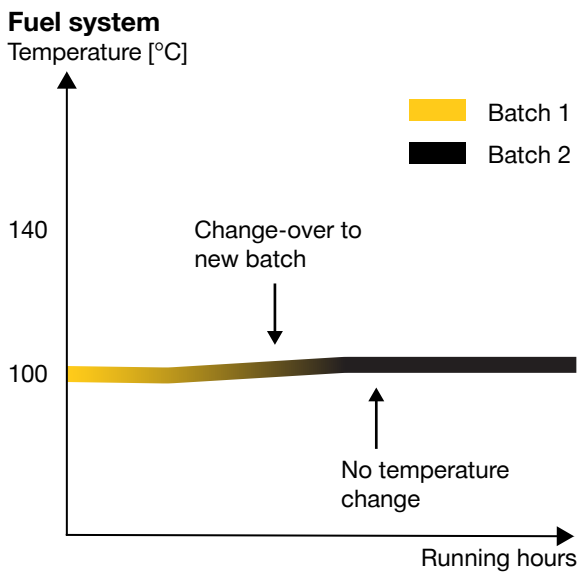

Fig. 21: The figures show a change-over from a fuel with a viscosity of 80 cSt at 50°C (Batch 1) to a fuel with viscosity 380 cSt at 50°C (Batch 2) without changing the temperature of the fuel. Note that the viscosity at engine inlet will be too high.

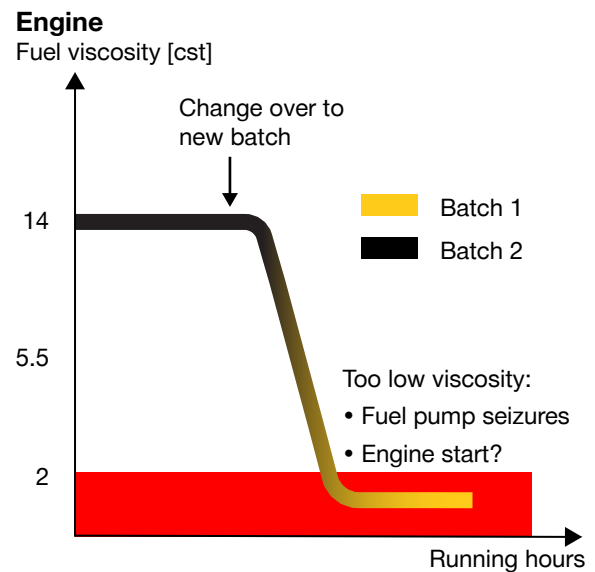
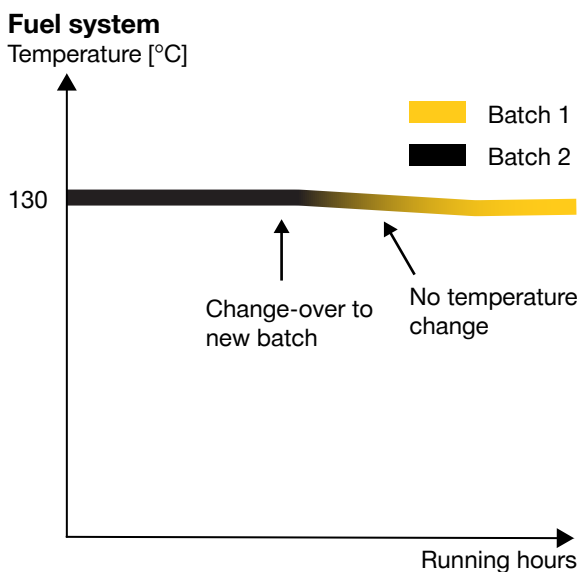

Fig. 22: The figures show a change-over from a fuel with a viscosity of 380 cSt at 50°C (Batch 1) to a fuel with viscosity 8 cSt at 50°C (Batch 2) without changing the temperature of the fuel. Note that the viscosity at engine inlet will be too low.

10. Fuel pump pressure

The pressure in the fuel pumps must be sufficiently high to be able to open the fuel valves and achieve fuel injection and, thereby, combustion. Worn fuel pumps increase the risk of starting difficulties because the fuel oil pump pressure needed for injection cannot be achieved.

On MC engines, an indication of fuel pump wear can be achieved by reading the actual fuel pump index and compare it with the test bed measurements. As a rough guideline, we consider the pump to be worn out for HSHFO operation when the index increase is 5-10, or more, under the same conditions as during sea trial. Such fuel pumps should be replaced for better engine performance. We advise that sufficient spares are kept on board for replacement at sea, if needed.

Due to the design, the fuel oil pressure booster on ME/ME-C/ME-B engines is

more tolerant towards low viscosity fuel compared to the cam driven fuel oil injection pump on the MC/MC-C engines, as illustrated in Figs 23 and 24. It is advisable to make engine start checks at regular intervals, and it is a necessity before entering high-risk areas (e.g. ports and other congested areas) where operation on low-viscosity fuel is expected. By such action, the individual low-viscosity limit can be found for the engine with corresponding worn pumps.

It is recommended to make a start check every six months, in the following way:

1. In a safe operation area, change fuel to an available distillate or other low viscosity fuel.
2. At different operating conditions, e.g. start, idle, astern and steady low rpm, gradually change the temperature of the fuel at engine

inlet, corresponding to viscosities of 3, 2.5 and 2 cSt. Test starting ahead and astern from the control room.

- 2 a. If the engine starts with the specific viscosity as required, then the engine is able to run on fuel with this viscosity level.
- 2 b. If the engine does not start, the starting index in the governor must be adjusted.

A possible outcome of the test may be that the engine requires a higher viscosity than achievable with the systems on board, due to for example fuel pump wear, engine adjustments and fuel temperature. Tests and calculations show that a worn-out fuel pump for an MC-engine cannot start on a fuel with a viscosity of 2 cSt.

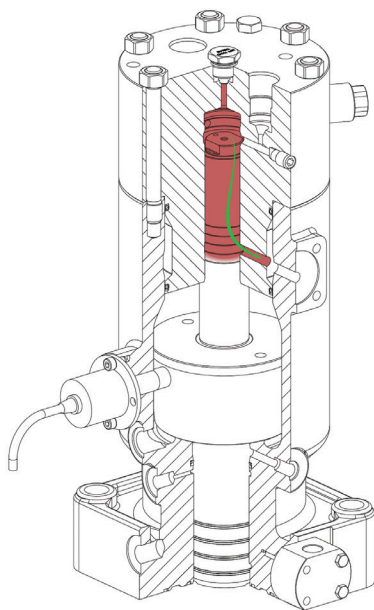

Fig. 23: ME engine – fuel oil pressure booster. Usually no problem with low-viscosity fuels because: 1. Plunger velocity is governed by supply pressure. 2. At start conditions it has 75-78% of full load supply pressure. 3. Long leakage path (green).

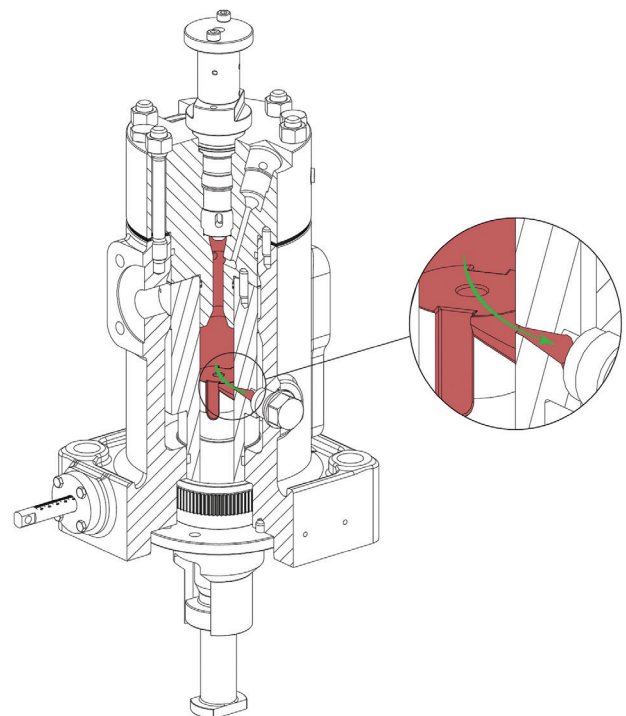

Fig. 24: MC engine – cam driven fuel oil injection pump. Test to find the low-viscosity limit because: 1. Plunger velocity is governed by engine rpm. 2. At start conditions it has 15% of the full load engine rpm. 3. Short leakage path (green). Solution: Use unworn fuel pumps.

11. Fuel change-over procedures

This section describes the change-over between fuels with different viscosity. High temperatures are used when operating on high viscosity fuel in order to reduce the viscosity to the required level before engine inlet. Rather low temperatures are used with low viscosity fuels to keep the viscosity sufficiently high before engine inlet. A change-over between the fuels means a change-over from high to low temperature or from low to high temperature. If the fuel is a medium viscosity fuel, and therefore used at medium temperatures, the temperature difference during a change-over may be smaller and, thereby, reducing the challenge that large temperature differences bring.

The injection equipment needs to be protected against rapid temperature changes, as the large temperature changes might otherwise cause sticking or scuffing of the fuel valves, fuel pump plungers or suction valves. The change-over must be carried out at low load (25-40% MCR) and in a controlled manner. The fuel temperature gradient must not exceed 2°C/min. (Figs 25 and 26).

Special care must be taken when going from a low-viscosity fuel, which is cold, to a high-viscosity fuel, which needs to be heated. When the warm fuel flows to the cold components, they will warm up, and the material will expand slightly. For example, the fuel plunger will warm up first, whereas the barrel contains more material and, therefore, its expansion will take longer time. This means that the clearance will decrease and thereby the risk of seizures increases. Changing the other way around, from warm to cold fuel, is less sensitive, as the plunger will cool down first, reducing in size and, thereby, increasing the clearance and decreasing the risk of seizures.

It is advisable to practice the change-over in deep waters before entering high-risk areas such as ports and other congested areas. The complete change-over procedure can be found in the operation manuals.

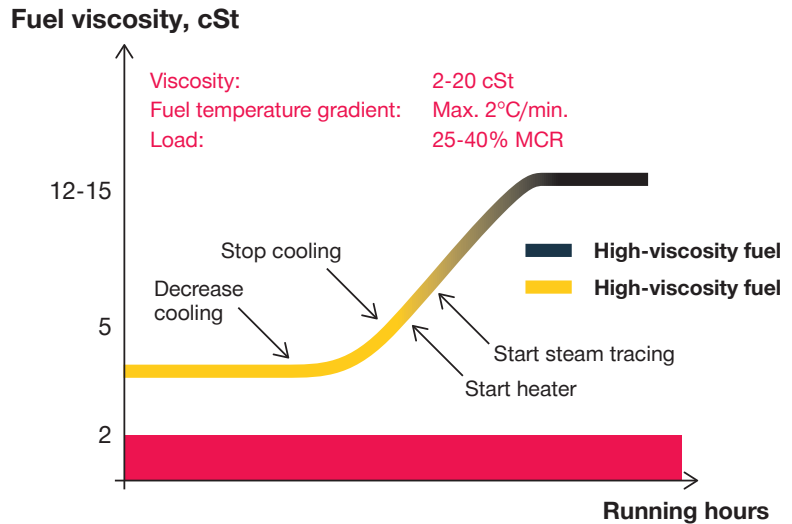

Fig. 25: Change-over procedure from cold, low-viscosity fuel to warm, high-viscosity fuel.

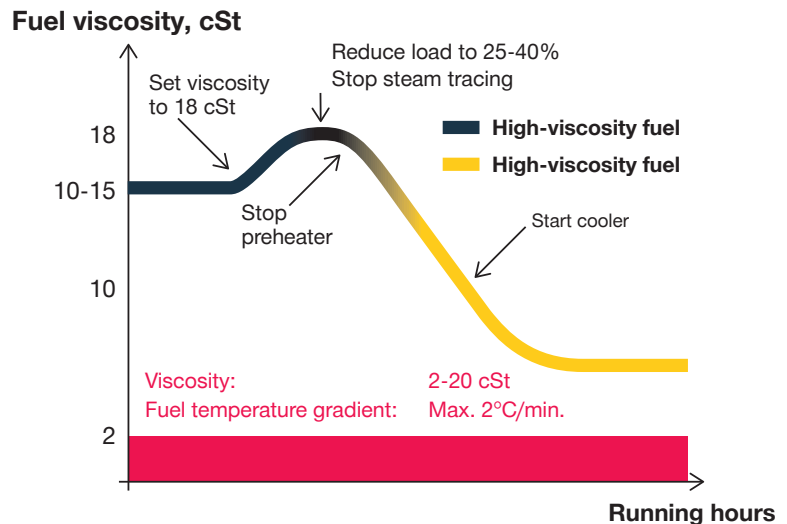

Fig. 26: Change-over procedure from warm, high-viscosity fuel to cold, low-viscosity fuel.

12. Lubricity

The refinery processes, which remove sulphur from oil, also impact the fuel components, which give the fuel its lubricity. Most refiners add lubricity-enhancing additives to the fuel that requires it, in order to fulfil the limits in ISO 8217. Too little lubricity may result in fuel pump seizures. However, MAN ES does not regard the lubricity of the fuel as a major issue. We have not heard of and/or experienced any failure due to the lubricity of the fuel. Our research tests show that we cannot provoke a failure due to lack of lubricity. We do not usually see the need to use lubricity modifiers. However, if there is a genuine challenge, then a lubricity modifier might solve the issue.

MAN ES has adopted the ISO 8217:2012 lubricity limit: HFRR (high-frequency reciprocating rig) wear scar limit: max 520 µm. We recommend testing the lubricity before using fuels with less than 0.05% sulphur. Fuel laboratories can test lubricity according to ISO 12156-1.

13. Fuel density

It is expected that the density of the 0.50% S VLSFO will vary between distillate range to residual range in different batches and within the same fuel grade (Fig. 27). The blue bars show data from 2017 and the striped bars show the expected, potential density distribution of 0.50% S VLSFO. Note that the expected “Percentage of samples” is more evenly distributed throughout the density range.

Fuel cleaning and density

In classic separators, it is important to change the gravity discs when the density of the fuel changes. If the gravity disc fitted in the separators is not suitable for the fuel in use, the oil-water interface will be incorrect and the cleaning efficiency compromised. The fuel will not be cleaned and water in the fuel may be led to the engine or the fuel will be led to the drain with the water.

In classic separators (purifiers) a gravity disc maintains the hydraulic balance between oil and water and sets the position of the interface. The correct interface position between oil and water should be outside the disc stack but inside the top disc (Fig. 28). If the interface is allowed to go into the disc stack the separation efficiency will decrease.

The most commonly used type of separators in newer ships, automatically adjusts the oil-water interface without the need of gravity discs. To support optimal fuel cleaning, automatic separators are recommended by MAN ES.

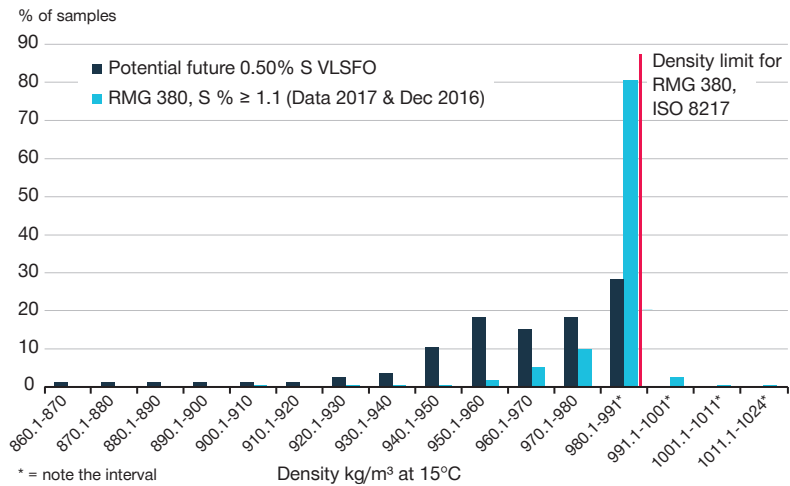

Fig. 27: Density distribution for RMG 380. Blue bars: data from 2017. Striped bars: Expected/potential density distribution for 0.50% S VLSFO. Data courtesy: LR FOBAS, evaluation and interpretation: MAN ES.

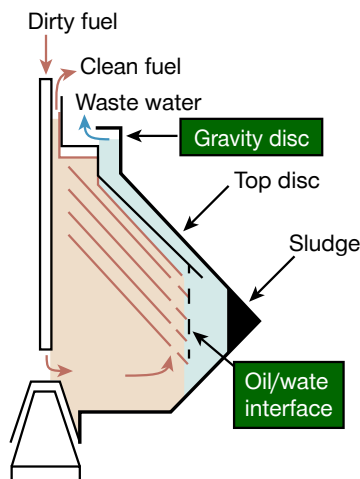

Fig. 28: Schematic of bowl in classic separator. Courtesy: Alfa Laval

14. Cat fines

As in HSHFO and 0.10% S ULSFO-RM, cat fines may also be found in 0.50% S VLSFOs. Cat fines are small, very hard particles which can wear the engine fast. It is highly recommended to use the fuel cleaning and conditioning system in an adequate manner to clean the fuel and remove the cat fines.

It is expected that the HSHFO systems on existing ships will be utilised for 0.50% S VLSFOs. The existing fuel cleaning systems for HSHFO are generally designed for high-viscosity, high-density fuel. Attention should be turned to whether the systems are capable of handling high-viscosity, high-density fuel and also low-viscosity, low-density fuel as these parameters may change from batch to batch. Adequate operating procedures for fuel cleaning should be implemented. It is recommended to always keep the Al+Si level as low as possible. The maximum is 15 ppm Al + Si at engine inlet for short periods (Fig. 29).

The fuel temperature through the separators should be kept as high as possible e.g. at 98°C, provided that the viscosity of the fuel at engine inlet is minimum 2 cSt. Flow through the separators should be kept as low as possible, and if separators are installed in parallel, we recommend using both separators simultaneously at low flow rates to have optimal conditions for removing cat fines. Recommendations from the equipment manufacturer should be followed.

Cat fines in sludge in tanks and fuel system

Some types of 0.50% S VLSFO could show a cleaning effect, which mean that they might dissolve sludge from the tanks and pipe walls from previous bunkers, and thereby release settled cat fines. Special care must be shown to avoid such sludge and cat fines to enter the engine. This could be the case both during the first change-over to 0.50% S VLSFO from the

traditionally used HSHFO, and also during the later changes between different types of 0.50% S VLSFO fuel batches. See also Section 17 Tank management and SL2019-674.

Cat fines in fuel after 2020

In July 2010, the regulation for max. sulphur content in the fuel in SECA was changed from max. 1.5% S to max. 1.0% S. As the cat fines containing stream of the FCC cracker is normally low in sulphur, it is a common blending stream for low-sulphur fuel. This can be seen in Fig. 30 below. The figure shows marine fuel samples analysed for sulphur and cat fines (Al+Si). It is obvious that the cat fines are abundant in the low-sulphur fuel, especially at the two limits: 1.5% S and 1.0% S.

In January 2020, the regulation for max. sulphur in the fuel in global waters changes to max. 0.5% sulphur. Again, as the cat fines containing stream from the FCC cracker normally is low in sulphur, it will most probably also after 2020 be an important part of the marine fuel pool. Consequently, the cat

fines will also be found in marine fuel after 2020.

More information on fuel cleaning and cat fines can be found in SL2017-638 and the paper “Cat fines. Impact on engine wear and how to reduce wear”.

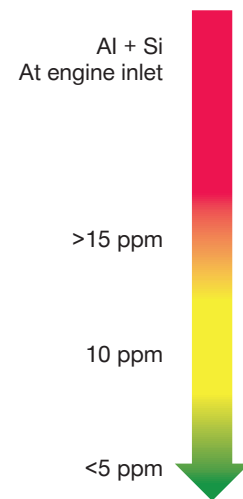

Fig. 29: Recommended max. content of cat fines entering the engine. SL2017-638.

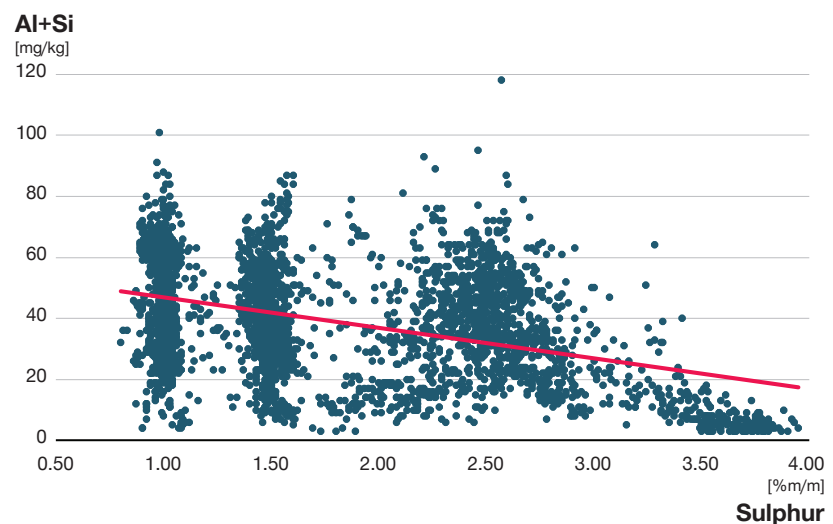

Fig. 30: Cat fines content in relation to sulphur content in the fuel as bunkered. Data from 2010 showing both SECA limits of max. 1.5% S and 1.0% S. Data courtesy: VPS, evaluation: MAN ES.

15. Cold flow properties

Cold flow properties of a fuel are defined by three parameters, cloud point (CP), cold filter plugging point (CFPP) and pour point (PP). The PP can be measured for both DM and RM grades and is the most frequently used. It is defined as the lowest temperature at which the fuel continues to flow (ISO 3016). The CP is defined as the temperature at which wax crystals start to form and the transparent fuel becomes cloudy (ISO 3015). It can only be measured in transparent fuels, e.g. DMA, and it is always higher than the

PP. The CFPP can be measured for DM grades and is the lowest temperature where the fuel still can flow through a standardised 45 micron filter (ASTM D6371).

Managing cold flow properties

In the distillate marine fuels system, it is recommended to keep a temperature between 30-40°C in order to minimise the risk of wax crystallisation and to decrease the risk of too low viscosities.

Higher temperatures increase the risk of viscosity becoming too low. It is recommended that the distillate marine fuel circulating cooler is always turned on during operation on distillate fuel to ensure an adequate temperature and minimising the risk of potential cold flow issues.

For RM-type fuels, the temperature in a fuel system, e.g. tanks and pipes should be minimum 10°C higher than the pour point of the fuel. If the temperature falls below the cloud point, waxy precipitations might form which could block filters and other equipment, and if the temperature falls below the pour point then the fuel cannot flow (Fig. 31).

If the fuel is reheated to above the cloud point, the waxy precipitations will dissolve, and if the fuel is reheated to above the pour point, the fuel will be able to flow again. This will require proper distribution of the heat and good recirculation of the fuel in the tanks and systems. This means that the fuel should be heated either in the tanks or by re-circulating it through an external heater (Fig. 32). The photo in Fig. 33 shows a severe case of waxy precipitations.

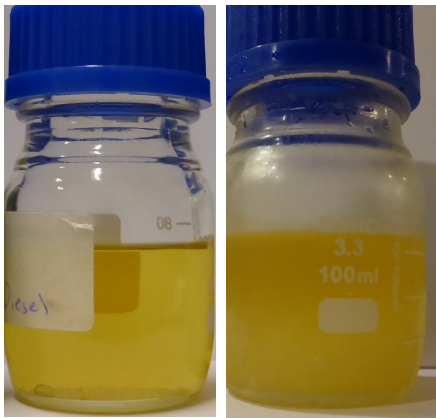

Temperature above cloud point and pour point

Temperature below cloud point



Temperature below pour point

Fig. 31: Photos of a distillate samples at different temperatures.

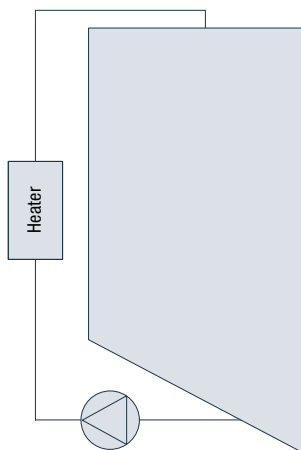

Fig. 32: Schematic example re-circulating the fuel and heating by an external heater



Fig. 33: Waxy precipitations in a fuel sample

16. Fuel stability and fuel incompatibility

Marine fuels are generally blends of different fractions of hydrocarbons with different characteristics. Important fuel blending fractions are paraffinic, naphthenic and aromatic molecules and asphaltenes. Paraffinic molecules are straight chained hydrocarbons, while aromatic molecules are cyclic. Asphaltenes are very large molecules consisting of a complex mixture of different components. They tend to agglomerate, and eventually precipitate if not kept in suspension. Aromatic molecules can help to keep the asphaltenes in suspension, while the paraffinic molecules cannot hold asphaltenes. The result of asphaltene precipitation is the risk of heavy sludging and blocked filters (Fig. 34). In this section fuel stability within the fuel and fuel incompatibility between different fuels will be explained and the implications of these are discussed.

Fuel stability – within a fuel

It is the responsibility of the fuel blenders and suppliers that the fuel is stable and homogenous at delivery. The fuel must also be stable in typical ship fuel systems and in the engine high-pressure fuel injection system. Stability of a residual fuel is defined by its resistance to breakdown and precipitate asphaltenic sludge, despite being subjected to forces, such as thermal and ageing stresses, while handled and stored under normal operating conditions.

Instability can happen if the fuel is not blended in such a way that the asphaltenes are well suspended and the rest of the fuel does not have the enough aromatic components to keep the asphaltenes in suspension. Asphaltenes need other aromatic components in order to stay in suspension, whereas if they are blended with high amounts of paraffinic cutter stocks, the risk of instability is large.

The result of an unstable fuel might be excessive sludge formation in tanks or further down in the fuel system, which then can block filters and separators. Once the asphaltenes have precipitated and formed sludge, there

is very low possibility that the process can be reversed and the asphaltenes can be re-suspended in the fuel again, neither by physical nor by chemical means.



Fig. 34: Heavy sludging and block separators as a result of either unstable fuel or incompatibility between two fuels.

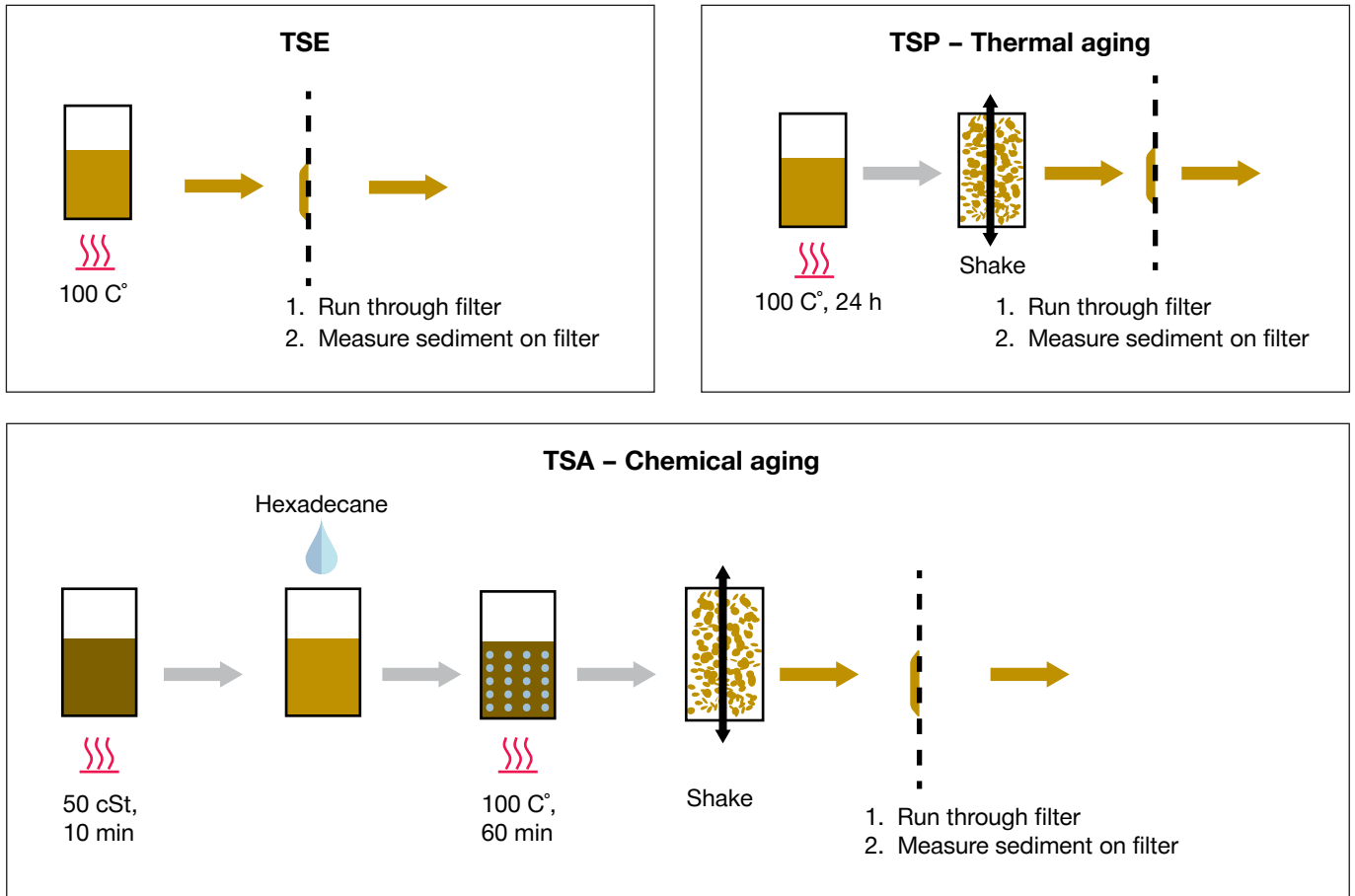

Fig. 35: Fuel stability testing. For DM-types: TSE (ISO 10307-1). For RM-types: TSP and TSA (ISO 10307-2)

Analysis methods – stability

In ISO 8217:2017 fuel stability for distillate fuels, DM grades, is characterised by Total Sediment by hot filtration (ISO 10307-1), which is typically called Total Sediment Existent (TSE) (Fig. 35, TSE). The method includes filtering a known volume of fuel through a filter. This method should correlate with the sediment currently existing in the fuel and which can likely be removed on board by the separators.

The stability for residual fuels, RM grades, is characterized by Total Sediment – Aged (ISO 10307-2), where either Total Sediment Potential (TSP) or Total Sediment Accelerated (TSA) can be used (Fig. 35, TSP and TSA). In the TSP method the fuel sample is heated to a specific temperature during a certain time before filtered. In the TSA method the fuel sample is

treated with chemicals before the filtration. These methods aim to correlate with the total sediments that can be formed under normal storage conditions and use.

In ISO 8217:2017, the limit for TSE, TSP and TSA is max. 0.10% mass. The higher the amount of sediment measured on the filter, the more sediment is expected to fall out of the fuel. Initial studies indicate that TSP is the most consistent method. More elaborate methods exist in the market to evaluate fuel stability, but experience with these methods is limited.

Fuel incompatibility – between different fuels

Compatibility is defined as the ability of two or more fuels to be commingled (mixed) at a defined ratio without

evidence of material separation, resulting in the formation of multiple phases, e.g. flocculation or separation of asphaltenes, making sludge in the fuel system. It is a measure of how stable a fuel, is when mixed with another fuel, and the tendency of the mixture to form sludge and deposits. The process of the asphaltenes dropping out can be very quick and is non-reversible. Sludge formation can occur immediately after mixing or later, depending on the stability reserve. The resulting issues are the same as for an unstable fuel; problems in the fuel cleaning system with sludge in tanks and further in the fuel system and, thereby, blocked filters and separators.

Incompatibility issues between marine fuels have always been present. However, MAN ES foresees that problems caused by incompatibility will be more frequent in the future. The challenge is that the 0.10% S

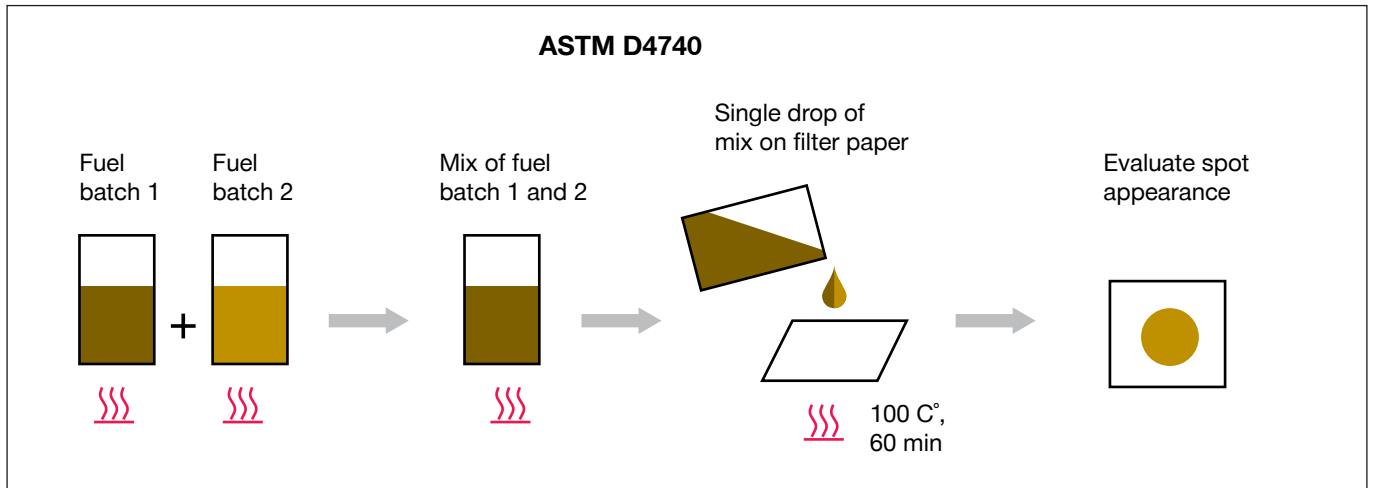

Fig. 36: Compatibility testing of two different fuel batches. Schematic process flow: ASTM D4740

ULSFO-RMs and 0.50% S VLSFOs will be made of a diverse range of various blending stocks, varying from highly paraffinic to highly aromatic. When mixing two fuels, one paraffinic and one aromatic, which are stable by themselves, the resulting mixture might be unstable. And the result will be an excessive amount of sludge because the asphaltenes in the aromatic fuel will drop out of the suspension. Note that these fuels could well be supplied as the same ISO grade, e.g. RMG 380, and with the same sulphur content. Hence, it is important to always remember that different fuel batches may not be compatible. It is recommended to keep different types of fuels separated.

Compatibility testing

Compatibility testing can be done manually with a kit on board (ASTM D4740, aka spot testing or coffee filter test) (Figs 36 and 37) or via an independent laboratory. The latter often being a slow process, since the ship will have left the port before the test results are finished. On board testing gives fast and indicative results. It is recommended to test the following fuel ratios: 90/10, 50/50 and 10/90, or as the actual ratio of the fuel batches will be in the tank. 50/50 is the worst case scenario.

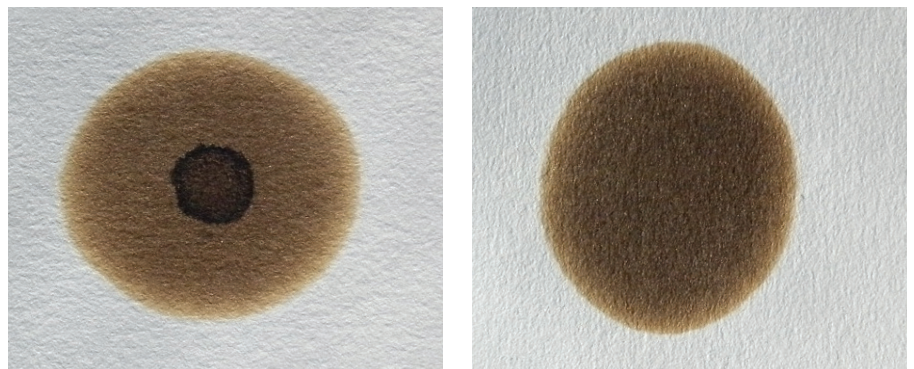

Fig. 37: Spot test: photos of mixture of two different fuels on filter paper. A. Incompatible fuel blend. The black ring is the asphaltenes which have precipitated. B. Compatible fuel blend. ASTM D4740 shows 5 different classes for compatibility, ranging from compatible to incompatible.

ASTM D4740 is developed for aromatic fuels containing asphaltenes. If a black ring or spot is formed in the middle of the filter paper, asphaltenes have precipitated and the fuels may be incompatible (Fig. 37). Hence they should be kept in separate tanks. The test requires that one of the fuels tested is a residual fuel, otherwise there will not be any asphaltenes to precipitate. Very paraffinic fuels and distillate blends may show false results, indicating that fuels are incompatible, when they are actually compatible. The false negative result is due to pigment separation. Care should therefore be taken when evaluating the results.

The reason why it is advisable to make compatibility testing at different blending ratios (90/10 and 10/90, 50/50)

is that it can be established if it is possible to mix at some ratio. If an aromatic fuel and a paraffinic fuel are mixed at the 90/10 ratio, e.g. 90% of an aromatic fuel and 10% of a paraffinic, this blend may be compatible. This is because the aromatic molecules in the fuel has enough solvency power to keep the paraffinic molecules in suspension, as well as the asphaltenes.

However, if the mixing ratio is the opposite, e.g. 10% of the aromatic fuel and 90% of the paraffinic, the resulting mix will most probably not be compatible. The long straight paraffinic molecules will not have the ability to keep the large, bulky asphaltenes in suspension and as a result asphaltenic sludge is created.

Paraffinic fuels are usually difficult to mix with other fuels. It is especially difficult to mix an aromatic type fuel into a paraffinic type fuel. It will be easier to mix a smaller amount of paraffinic type into an aromatic type fuel. Hence, the blending ratio is very important. Fuels with similar viscosity, density and pour point often show acceptable compatibility, as they are probably the same type. If they are very different in these characteristics, they should probably not be mixed, due to the high risk of incompatibility (Fig. 38).

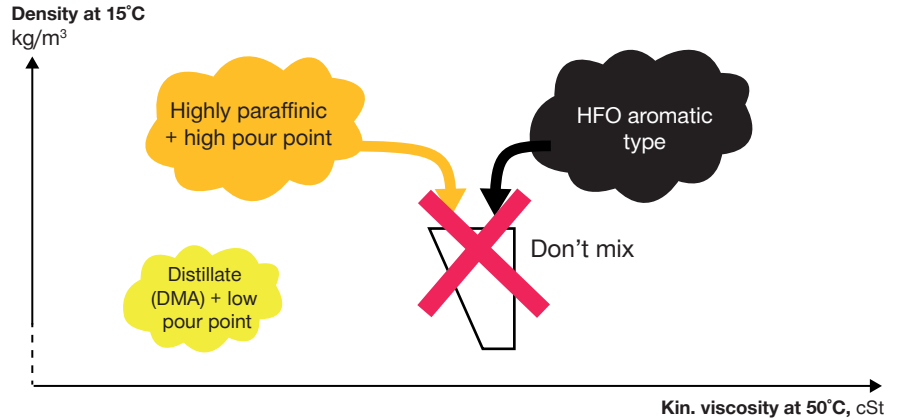

Fig. 38: Keep different fuels separated.

Managing stability and incompatibility of fuels

Recommendations for handling of fuels are given below:

1. Avoid mixing different fuel batches.

Always keep different batches of fuels in separate tanks. It is recommended to have dedicated tanks or different types of fuels. Fuels should not be mixed until it is ensured that the fuels are compatible with each other.

- a. Empty tanks as much as possible before bunkering a new fuel batch.
- b. Install more tanks in the ship, so that different fuel batches can be bunkered and stored in different empty tanks. Section 17 Tank management.

2. If mixing of the fuels is unavoidable.

- a. Reduce the amount of fuel in the tank as much as possible before bunkering the new fuel. Try to keep the blending ratios as large as possible, e.g. 90:10 or 80:20. A ratio of 50:50 is the worst case.
- b. Fuels with similar viscosity, density and pour point often show acceptable compatibility, as they are probably the same type.
- c. Check compatibility of the fuel in the tank and the new fuel.
 - i. Use on-board method for indication of compatibility: Spot-testing (ASTM D4740, aka coffee filter testing).
 - ii. Use lab methods, if the fuels are available for testing.
 - iii. If the fuels indicate compatibility, mixing may be possible.

3. Establish good fuel switch-over procedures in advance. (Section 11 Fuel change-over procedures)

4. Establish procedures for fuel cleaning in advance, both for normal operation, but also for when excessive sludging occurs.

17. Tank management

It is recommended to check each ship for the amount of different fuel tanks and how they are connected. Depending on the result, different procedures have to be made in order to manage incompatibility between different fuels. Examples are given below to two different types of systems.

1. Flexible fuel system: Separate fuel lines, making it easier to handle different fuel types (Fig. 39).
2. Simple fuel system: Shared fuel lines, where more attention has to be paid to the fuel system handling when changing fuels (Fig. 40).

Multiple fuel tanks are installed in the flexible system, and the fuel lines from storage tank to service tank are kept totally separated. This enables the ship to use multiple different fuel types in an easy and flexible way without the crew having to worry too much about whether the different fuel types and batches are compatible, as the tanks can be totally emptied before a new fuel batch is introduced.

In the simple system, only the fuel storage tanks are kept separated. The crew must be very careful to make sure that settling tanks and service tank are emptied as much as possible before a new batch of fuel is filled in the tank. For this system, special attention and care should be taken on whether the different fuel batches are compatible.

Tank layout, transfer systems and fuel treatment layout varies from vessel to vessel. Consequently, it is not possible to make a common recommendation for the optimal procedure for switching between fuels. Below are some general recommendations.

Changing fuel batch in the flexible fuel system

- Always empty bunker tanks completely so that only the unpumpable heel will be mixed with

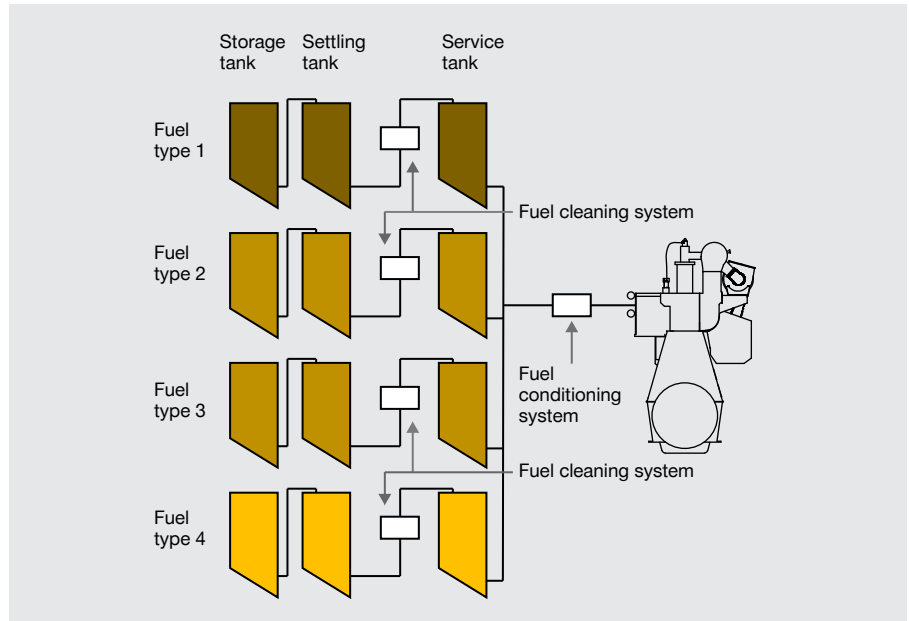

Fig. 39: Schematic: Flexible fuel system

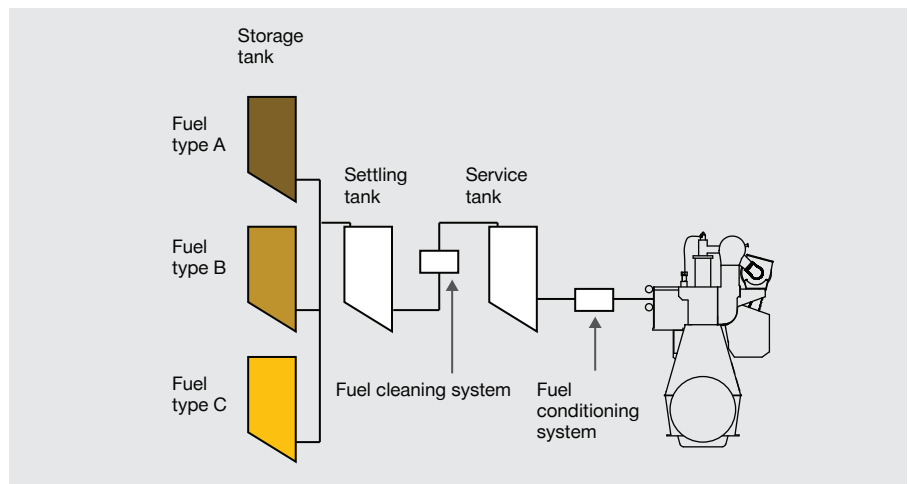

Fig. 40: Schematic: Simple fuel system

the new fuel being bunkered. Most tanks have unpumpable volumes under 2%.

- Most vessels have auto-filters after the service tank. In case the backflush frequency becomes excessive due to sludge formation, consider switching to distillate (e.g. DMA) in between the two batches to prevent engine blackout due to lack of fuel.

Changing fuel batch in the simple system

- Always empty bunker tanks completely, so that only the unpumpable heel will be mixed with the new fuel being bunkered. Most tanks have unpumpable volumes under 2%.
- Always perform spot testing (ASTM D4740) of the previous and the following fuel batch.

- If the test shows incompatibility, ensure that settling tank is empty before filling up with new fuel.
- Stop the flow through the separators until the level of the service tank is as low as deemed safe.
- Start the separators to replenish the fuel in the service tank.
- The replenishing rate should be kept as slow as possible in order to be able to use as much of the previous fuel in the service tank and keep the mixing ratio as low as possible.
- Most vessels have auto-filters after the service tank. In case the backflush frequency becomes excessive due to sludge formation, consider to switch the engine to distillate (e.g. DMA) in between the two batches to prevent engine blackout due to lack of fuel.

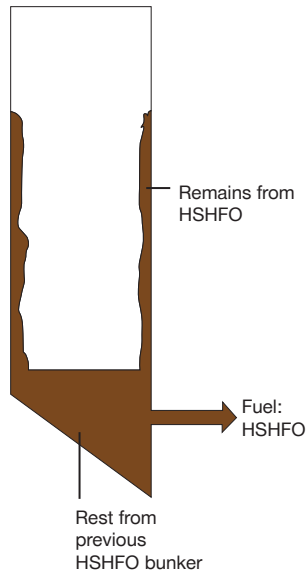

Fig. 41: Fuel tank with remains of HSHFO from previous bunkers.

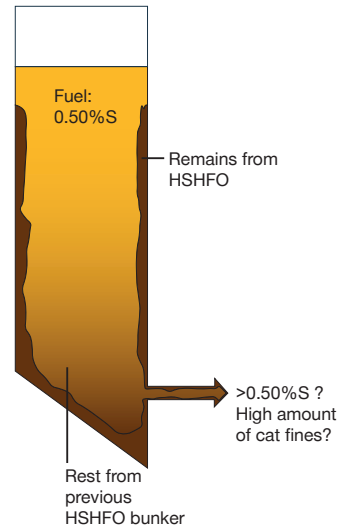

Fig. 42: Fuel tank filled with 0.50% S VLSFO on top of rest of HSHFO. The rest may be high in sulphur. The rest is mixed in the new batch and may cause increased sulphur content in the fuel leaving the tank.

Change over from HSHFO to 0.50% S VLSFO

By January 2020 the ship must comply with the 2020 regulation. This means that the engine must burn max. 0.50% S fuel, and that the fuel delivered must be with max. 0.50% S. The shipowner should make a plan so that compliance can be assured. The remaining high-S fuel should be used up or discharged off, and new 0.50% S fuel should be purchased. It is important to make a plan make sure that the sulphur content is max. 0.50% at engine inlet. The fuel can very easily be contaminated by the previous high-S fuel, which will cause the sulphur content to be higher than 0.50% S at engine inlet. This has to be avoided. Tank illustrations are shown in Figs 41 and 42.

The owner may choose to clean the tanks and systems or to dilute the remaining high-sulphur fuel to a compliant level. Manual cleaning of the tanks is time-consuming, resource-demanding and expensive. Some additives claim to be able to clean the tanks and fuel system. MAN ES does not have any experience with such additives.

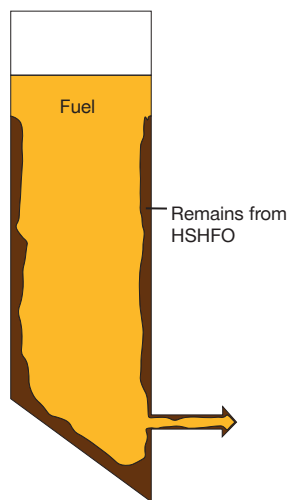

Fig. 43: Fuel tank with remains of HSHFO from previous bunkers on the tank walls. The remains may be high in sulphur and cat fines.

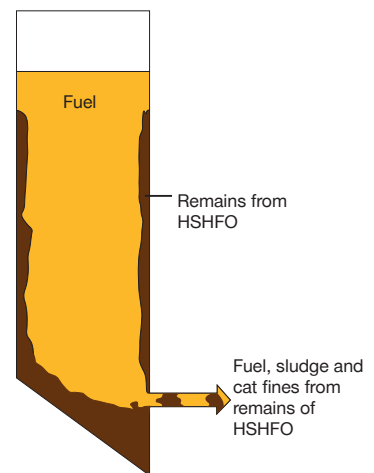

Fig. 44: The remains may dissolve in new bunker batches and cause sludge and contamination of the new batch.

All the fuel tanks may be covered inside with remains of the HSHFO, which has been used for many years (Fig. 43). These remains may be high in sulphur and cat fines, and the new fuels may be able to dissolve the remains and cause sludge and sulphur and cat fines contamination of the new fuel batch (Fig. 44). It is important that the sludge and the cat fines do not reach the

engine. Please see SL2019-674 for advise on fuel tank cleaning.

If the owner chooses to remove the remains of HSHFO by diluting and dissolving with low-sulphur fuel, it may have to be repeated several times with different fuel batches before 2020 as the fuel can only dilute and dissolve a limited amount (Fig. 44).

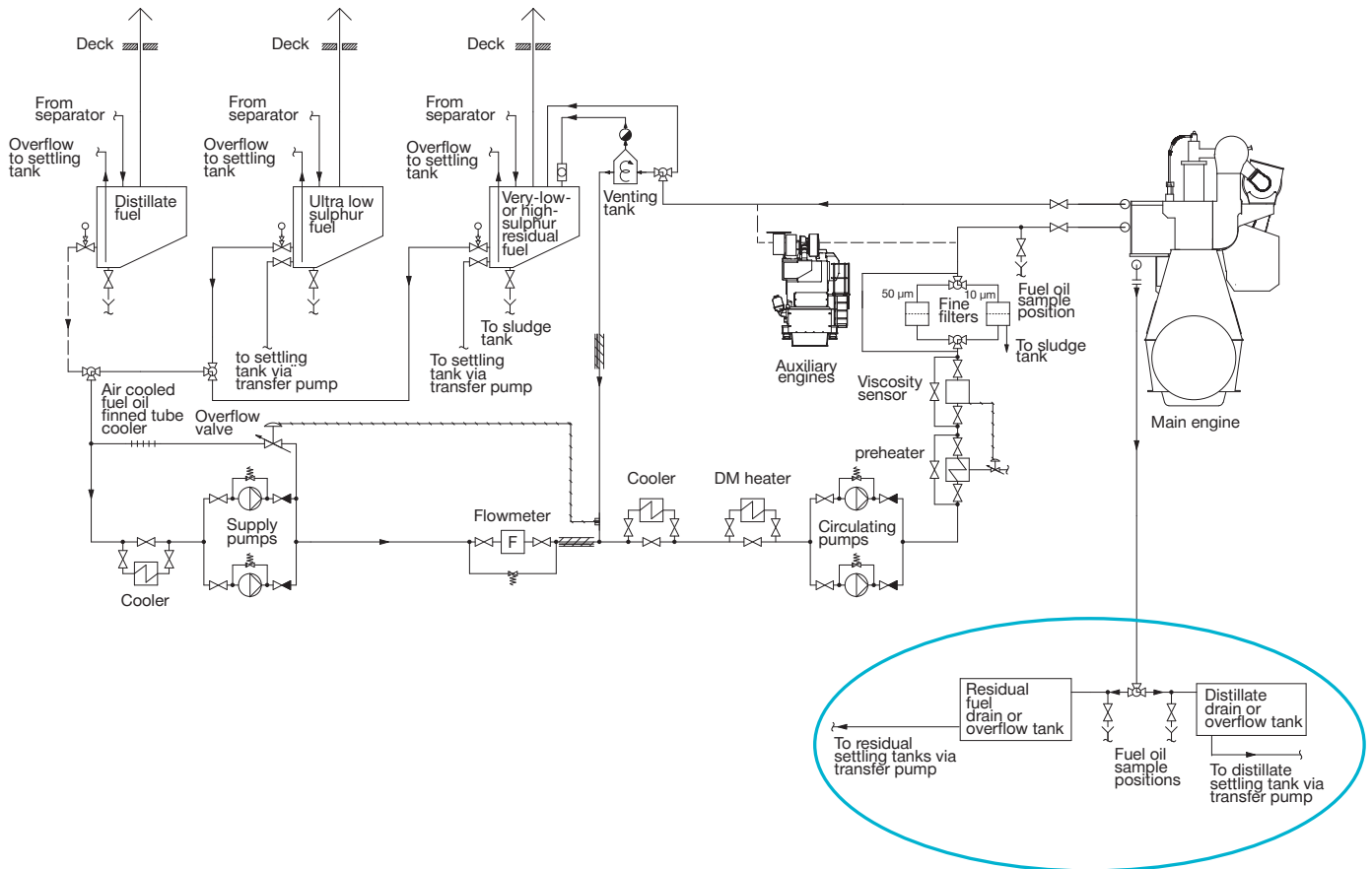

Fig. 45: Fuel system diagram. Purple circle: fuel pump drain arrangement.

Fuel pump drain overflow tank

A small amount of fuel drains through the main engine fuel pumps, during normal operation. Traditionally, this fuel is led back to the HFO settling tank. As the different 0.50% S VLSFO types might be incompatible, it is important to keep the different fuel streams separated. We recommend that the drain system is updated to either of the options below and shown in Fig. 45.

1. Two overflow tanks. One tank with piping leading to the residual fuel type settling tank and one tank with piping leading to the distillate fuel type tank.

2. Installing an extra line from the overflow tank. The overflow tank will have piping both to the residual settling tank and to the distillate tank. The overflow tank has to be emptied before switching to a different fuel.

As it takes some time for the complete change-over from one fuel batch to the next, there will be a time delay before the crew can switch over from one tank to the other. This time delay depends on the actual fuel system, load etc.

The amount of drain from the fuel pumps will normally be small compared to the volume in the settling tank, so it is not expected that the traditional solu-

tion where the fuel pump drain is led to the settling tank will cause serious problems. See Section 17 regarding compatibility of fuels.

18. Combustion characteristics – two-stroke engines

There are concerns that new types of 0.50% S VLSFO may show unfavourable combustion characteristics and in rare cases this could occur. However, several engine tests made over the years show that such fuels do not have any major influence on the two-stroke engines. The fuels ignite and burn as other fuels.

In this section we present results from two-stroke engine testing of Santos fuel from South America, with presumably bad combustion characteristics, and results from testing a very aromatic, high density fuel (HDA) which has very bad combustion characteristics. The HDA is a special stream in a refinery, which is not presently used for marine applications, but the refinery considers to include this stream in future 0.50% S VLSFO fuel blends. HDA should be regarded as a worst case scenario and if the engine can operate on HDA, it should also be able to operate on all future VLSFO blends (CIMAC paper no: 374).

The main difference between two-stroke and four-stroke marine diesel engines with regards to combustion is, that the two-stroke engines have much lower speed of revolution. The significantly increased cycle duration allows for a much longer ignition delay of the fuel and leads to very different combustion characteristics. The diffusion/mixing controlled combustion process is therefore more dominant for two-stroke

engines. Hence, giving a higher combustion controllability that avoid abnormal combustion patterns, i.e. diesel knocking.

The compression ratio is also generally higher for two-stroke engines and the resulting high gas temperature at end of the compression stroke guarantees the ignitability of the fuel. At the same time, the miller timing is a practical tool to control the compression temperature that also enable an extended expansion stroke which lead to better combustion and thermal efficiency of the engine.

Results from service

Around 2005, when the industry worried about ignition quality of the Santos fuels, there was a case where the Estimated Cetane Number (ECN; according to [4]) of the fuel was measured to be below 5. This is the minimum limit for the measurement equipment. An ECN of 5 corresponds to a very long ignition delay and correspondingly low heat release rate which is generally bad characteristics for a fuel intended for diesel engines. However, the 9K90MC-C MAN B&W engine was able to operate without failure for the entire journey on this fuel. Generally, we hear very little from service regarding combustion performance, and it is presumed that the MAN B&W engines in general are able to operate without failure on the Santos fuels.

Characteristics of Santos fuel and HDA

In Table 6, selected fuel characteristics for the Santos fuel, the HDA and the HDA/Diesel blend compared to ISO 8217 limits are shown. The HDA fuel is not fulfilling ISO 8217:2017 nor the 2005 version, as the density is too high (Fig. 46).

Neither the HDA nor the HDA/diesel blend fulfil ISO 8217:2017, since the density to viscosity relationship, expressed by the CCAI, is too high. ISO 8217:2010 and later versions have a CCAI limit for residual fuels, but earlier versions of ISO 8217 do not. The HDA/diesel blend does fulfil the ISO 8217:2005 for density.

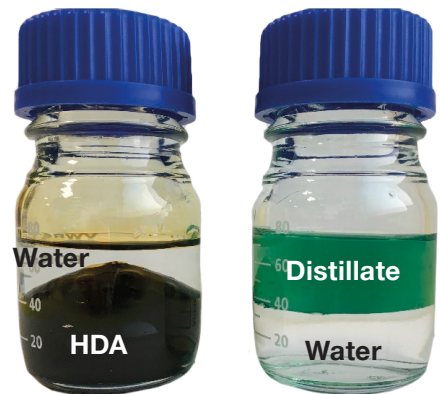

Fig. 46: The density of the HDA fuel is very high, even higher than water.

Selected characteristic for the fuels

Characteristic	Santos	HDA	HDA/diesel 90/10% v/v	ISO 8217:2005	ISO 8217:2017
Density (kg/m ³ at 15°C)	992	1020	1000	Max.: 1010	Max.: 1010
Viscosity (cSt at 50°C)	372	10	7.4	Min.: 1.5 Max.: 700	Min.: 2 Max.: 700
CCAI (-)	853	937	924	Not included	Max. 870
Sulphur (m%)	0.87	0.06	0.05	Max. 4.5	Statutory requirements
Al+Si (ppm)	11	0	0	Max. 80	Max. 60

Table 6: Selected characteristic for the fuels, compared to ISO 8217:2005 and 2017 limits.

Theoretical combustion behaviour by lab testing

The fuels were tested in the lab to establish a theoretical combustion behaviour as according to the FIA test (IP 541: Constant volume combustion chamber method), giving values for ECN, ignition delay, pressure increase during testing, main combustion period etc. The results are shown in Figs 47-48 and Table 7. The Santos fuel show low values compared to the reference-diesel and the reference-HFO. However, the HDA fuel ignites even later and burns much slower than the Santos fuel. The ECN method cannot measure lower than 5 ECN, hence the HDA value of 6.3 is very close to the minimum. It is questionable if the ECN method is able to give useful results for fuels with such unusual combustion behaviour as shown by the HDA.

Engine testing at 4T50ME-X

The tests presented have been made at the Copenhagen test engine, 4T50ME-X (50 mm bore and 7080 kW and 123 rpm at MCR) at two different occasions. The Santos fuel tests were made in 2005 while the HDA fuel was tested in 2018.

Santos fuel testing at 4T50ME-X

The tests with Santos fuel were compared to similar tests with a reference-diesel and tests with a normal low-sulphur heavy fuel (reference-HFO). In general, the engine experienced little difference depending on the fuel type. This proves, as expected that a MAN B&W two-stroke diesel engine can burn diesel, HFO and the Santos fuel, without any major issues. Several different operating conditions were evaluated, of which only a small selection is presented here.

The in-cylinder pressures at 100 and 25% load are shown in Fig. 49 for reference-diesel, reference-HFO and the Santos fuel. At high load (100%) there is practically no difference

ROHR curve

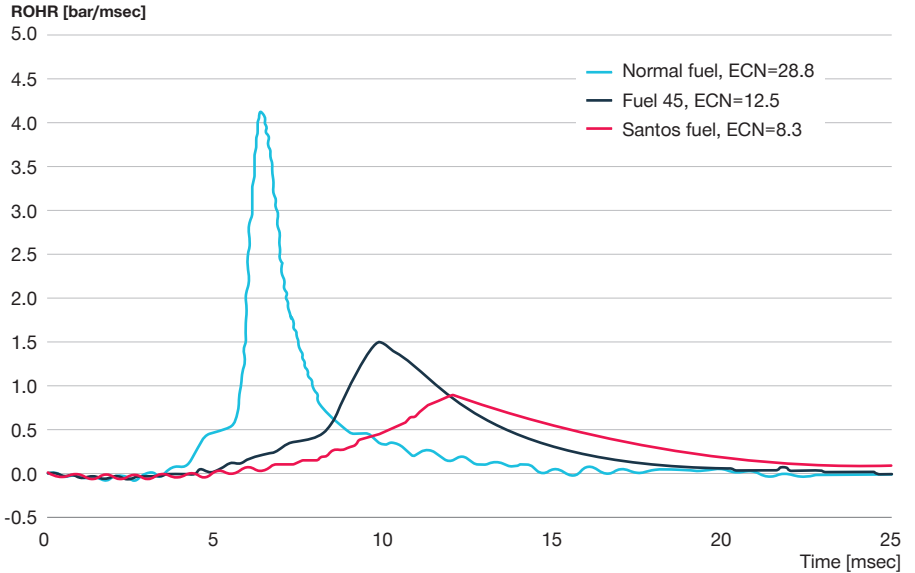

Fig. 47: Rate of heat release (ROHR) versus time. ECN testing: Red curve: Santos fuel (8.3 ECN). Light blue curve: Reference-diesel (28.8 ECN). Dark blue curve: Reference-HFO (12.5 ECN).

Selected parameters from the lab combustion testing as according to IP 541.

Parameter	Santos	HDA	Unit
ECN (Estimated cetane number)	8.3	6.3	-
EC (end of combustion)	33.9	43.3	msec
MCP (main combustion period)	22	44	msec
AR (accumulated rate of heat release)	6.6	0.87	-

Table 7. Selected parameters from the lab combustion testing as according to IP 541.

ROHR curve

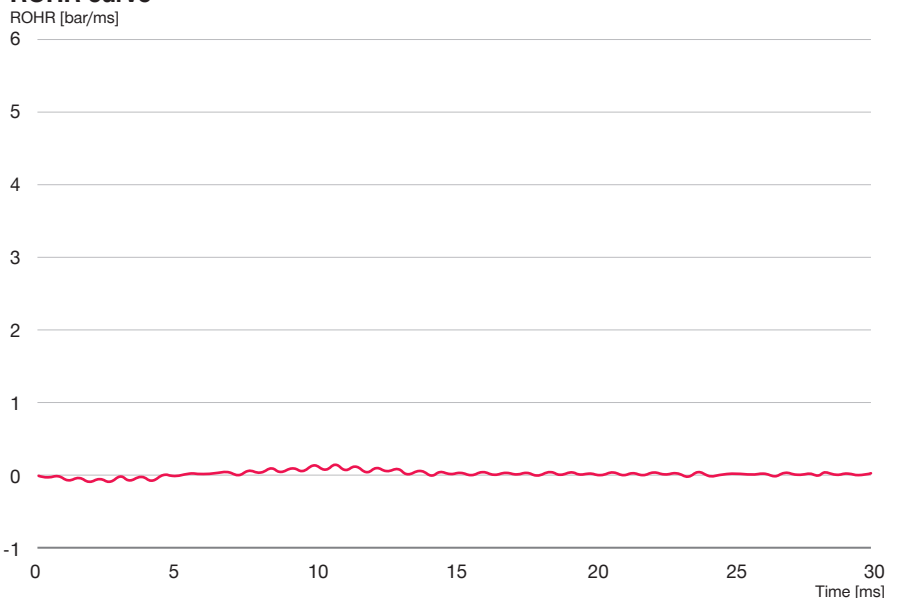

Fig. 48: Rate of heat release (ROHR) versus time. ECN testing: HDA fuel (6.3 ECN)

between the pressure curves for the three fuels. This is because the in-cylinder temperatures are high enough to reduce ignition delays and improve the combustion quality which makes the fuel quality effects insignificant.

At 25% load, there is a slight difference. At low load, the temperatures are low enough to allow fuel quality differences to be apparent. A longer ignition delay generally leads to a larger initial premixed combustion with a rapid heat release just after the start of injection. It is a process similar to diesel knocking. This can initialize pressure oscillations in the combustion chamber and in the channel leading to the pressure sensor in the cylinder cover. These pressure oscillations are seen as ringings on the pressure trace after the start of combustion.

The reference-diesel had the shortest ignition delay and highest ECN. It gave also the lowest amount of ringings. Reference-HFO had slightly more ringings while the Santos fuel promoted even more ringings indicating an even more delayed ignition after injection.

However, the magnitude of the pressure oscillations is by no means critical for the engine and the test show that it is safe to operate on the Santos fuel.

Additionally, the ignition delays for the three fuels were measured using optical methods. The ignition delay for the Santos fuel was longer than for the two other fuels at low load (low pressure at injection) where the lower cylinder pressure and lower temperatures affects the ignition the most. However, the effect was rather small with ignition delays that never reaching above 5 ms.

The conclusion is, that the fuels with a lower ignition quality, like the Santos fuel, do not influence the overall engine performance but the influence can be seen on the measured pressure trace.

Raw cylinder pressure

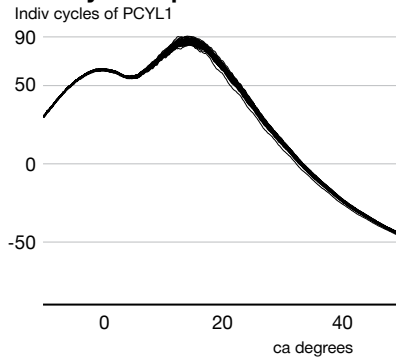

Raw cylinder pressure

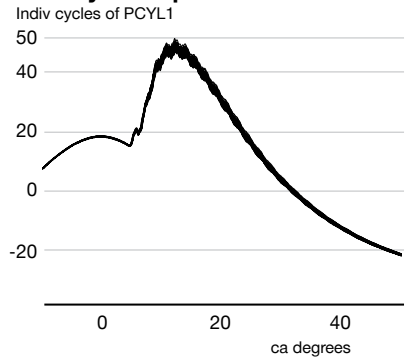

Raw cylinder pressure

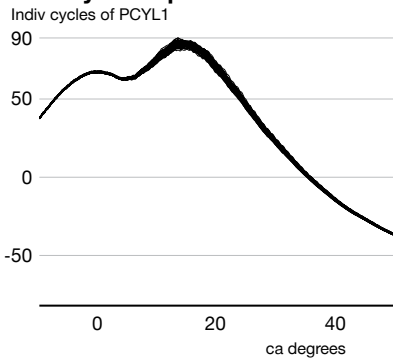

Raw cylinder pressure

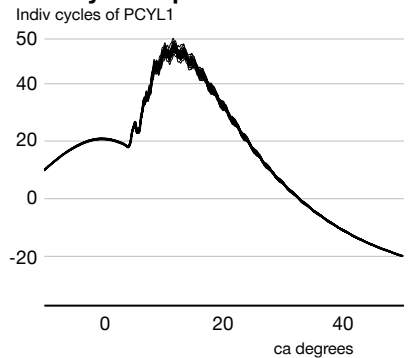

Raw cylinder pressure

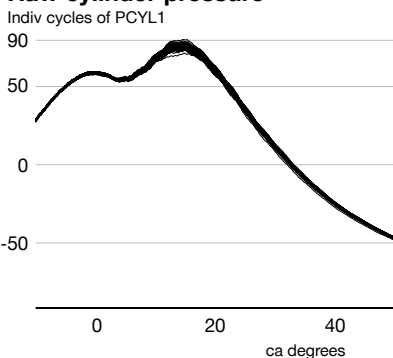

Raw cylinder pressure

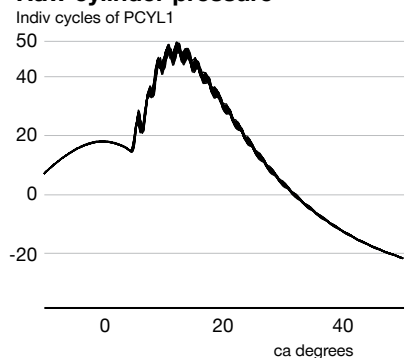

Fig. 49: Measured (not processed) cylinder pressure (arbitrary units) for reference-diesel (top), reference-HFO (middle) and the Santos fuel (bottom) at 100% load (left) and 25% load (right).

HDA testing at 4T50ME-X

The HDA fuel was tested on the 4T50ME-X test engine in order to evaluate the effect of the fuel on engine performance. The HDA fuel was compared to a reference-diesel, and to a mixture of HDA and diesel (10% by volume). The HDA fuel is one of the

worst fuels which were possible to localise in terms of ignition quality.

The three fuels were tested at 25, 50, 75 and 100% load. The engine burned HDA acceptably at all loads. The apparent heat release at 75% load for the reference-diesel (DI), pure HDA and HDA mixed with 10% diesel (by volume)

are compared in Fig. 50. It is evident that the overall combustion of the HDA fuel is very similar to that for diesel. There is no significant change in heat release rate caused by changing fuel between the tested cases.

Although the general combustion is fine for the HDA there is, similar as for the Santos fuel, an observable difference in ignition delay. At 25% load the HDA fuel give rise to slight pressure oscillations in the combustion chamber after start of combustion. The differences between the combustion of the three fuel are shown in Fig. 51.

Further calculations show that the pressure oscillations are roughly two times as strong for HDA compared to the reference-diesel. The HDA also has a clear trend with higher values at lower load. This is consistent with the lower gas temperatures at part load that further elongates the ignition delay. The same trend is not seen for the reference-diesel. Comparing HDA to the HDA with 10% diesel it is clear that the added diesel did not improve the ignitability of the HDA.

Heat release – 75% load

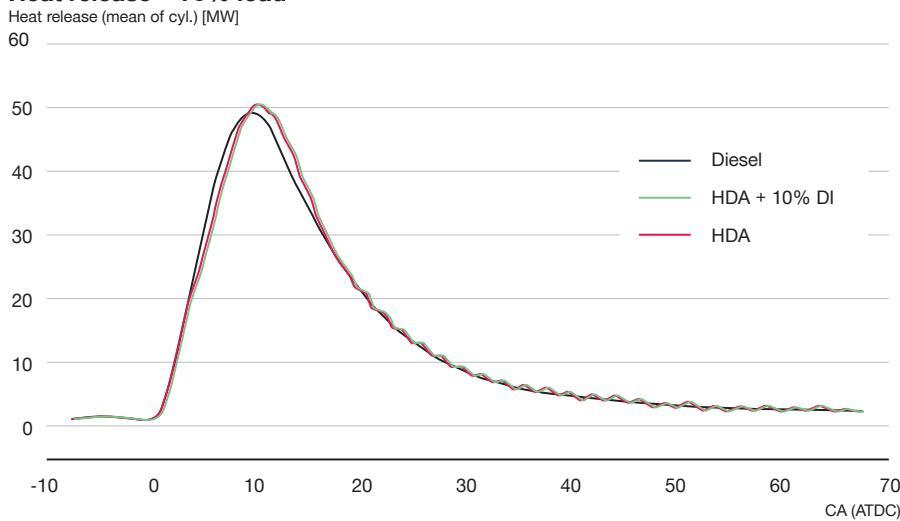
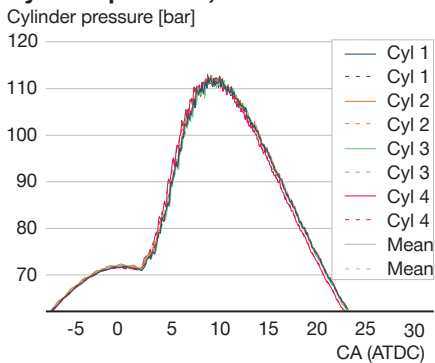
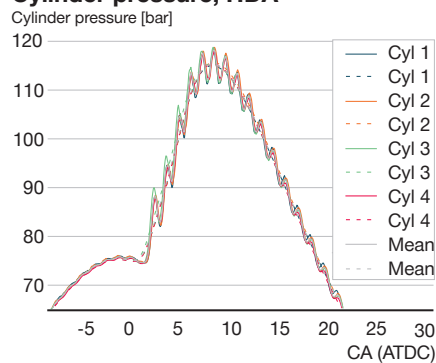

Fig. 50: Apparent heat release rate at 75% load.

Cylinder pressure, diesel



Cylinder pressure, HDA



Cylinder pressure, HDA + 10% DI

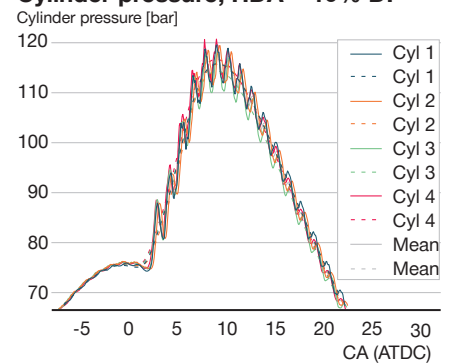

Fig. 51: Cylinder pressure for reference-diesel (a), HDA (b) and HDA with 10% diesel (c) at 25% load. The pressure oscillations are a result of in-cylinder acoustics that are excited by a somewhat harder ignition due to the longer ignition delay with HDA. Adding 10% diesel to the HDA has little effect.

Emissions were also measured and results show that they did not change significantly when comparing the HDA to the reference-diesel. This is illustrated in Fig. 52 which shows the AVL filtered smoke number (FNS) for each test. The values are in general very low and the trends very weak. In general it can be concluded that the high aromatic content of the HDA did not increase the engine-out smoke significantly.

The conclusion is that the fuels with lower ignition quality do not influence the overall engine performance negatively. It is possible to operate a marine two-stroke with both the Santos and the HDA fuel. This is also consistent with the service experience that is available for Santos fuels which clearly show that MAN B&W two-stroke engines are capable of long term operation on Santos fuels.

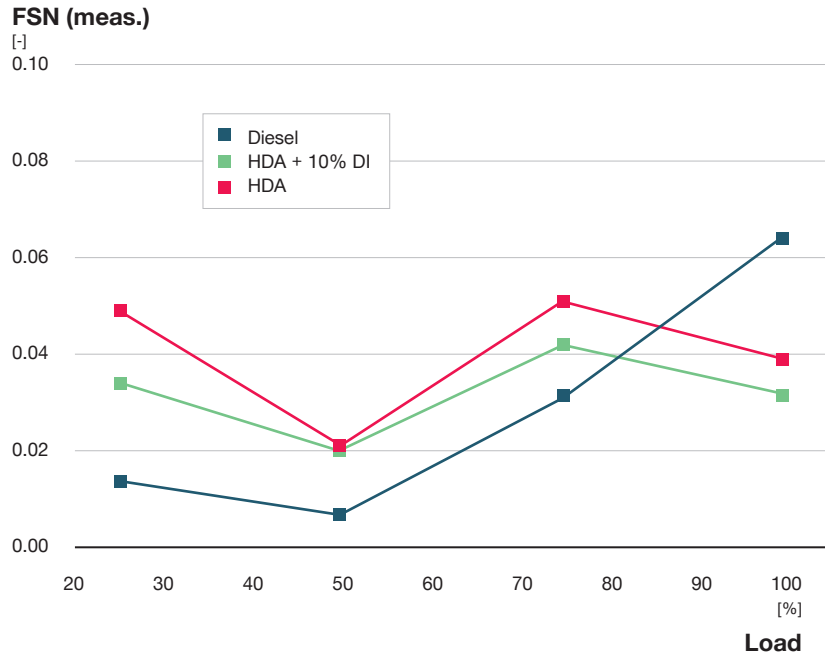

Fig. 52: AVL filtered smoke number (FNS) for HDA, DI and HDA mixed with 10% diesel as function of load.

19. Cylinder condition

A good cylinder condition depends on many parameters, from engine design to operation pattern and maintenance level. The condition should be followed closely and the operators should act on the information obtained. The most important factors to obtain a good cylinder condition when operating on 0.50% S VLSFO are installing cermet-coated piston rings (SL2018-659), using the correct cylinder lube oil at the correct feed rate, and increasing the corrosion in the combustion chamber slightly by decreasing the jacket cooling water temperature (if possible). Always refer to the most recent guideline available for your specific engine type, e.g. Service Letters (currently SL2019-671) and Circular Letters on lubrication, piston rings and cylinder condition.

20. Fuel testing – in laboratory and in service

New types of fuel will emerge on the marine market. The characteristics of the fuels will vary widely, but most of them will be within the ISO 8217 specification. MAN B&W two-stroke engines can generally operate on all fuels within the limits of ISO 8217. However, there might still be questions concerning handling, combustion and cylinder condition of these new types of fuels.

In order to facilitate the transition to new types of fuels, a guideline is presented on how to test new fuels in the laboratory and in service. It is not necessary to follow these procedures with all fuels. But if the fuel has characteristics very different from the traditionally used fuels, it could be advisable to take some extra precautions. It is advisable to bring some extra fuel on board, e.g. DMA (marine gas oil) in case of problems with using a fuel that cannot be managed on board. It is important to remember to prepare clear and organised written and photographic documentation so that it is easy to track the events, in case of any issues.

Laboratory analysis

It is always advisable to make a general fuel analysis, and a complete ISO 8217 analysis is the cornerstone. We recommend using the latest edition of the specification and standardised analysis methods. Cold flow properties of the fuel; pour point (ISO 3016), cloud point (ISO 3015) and cold filter plugging point (ASTM D6371, IP 309 or IP 612), are very important factors to pay attention to, as well as the viscosity and density. Testing the stability within the fuel and the compatibility with the other fuels on board are especially important if there is a risk of commingling, e.g. TSE/TSP/TSA (ISO 10307-1/2). We recommend keeping the fuels in separate tanks.

For very uncharacteristic fuels one can consider doing even further analyses

which give indication on combustion properties and composition of the fuel. These include:

- ECN analysis (IP 541), which gives indication on combustion properties. Note: MAN B&W two-stroke engines are usually not very sensitive to low ECN values.
- Boiling curve (ASTM D1160) which gives an indication on composition of the fuel.
- Elements: H, C, N, S, O in m/m%, for example ASTM D5291, ASTM D5762, ASTM D4294.
- Net heat of combustion – by bomb calorimeter, ASTM D240. Especially important for biofuels.

Service testing

During the service testing operation, the aim is to investigate which of the optimal settings ensures that the fuel system and engine perform as intended. If issues arise, they should be taken care of immediately, and if major problems occur, a switch to DMA or another familiar fuel should be performed. It is recommended to make engine and system inspections before, during and after the test. As always, it is important to pay attention to fuel temperature when switching fuels. Below is a guideline on what to consider when testing fuels:

- **Fuel samples** of the fuels on board should be taken and sent for analysis, e.g. the commercial sample, as described in previous part, Laboratory analysis. After receiving the results, act based on the results. It is not necessary to have three types of fuels on board during service testing.
- Test fuel (fuel with unfamiliar characteristics, maybe a 0.50% S VLSFO)

- Familiar fuel (could be any fuel that the crew is familiar with)
- 0.10% S USLFO-DM, preferably DMA
- **Compatibility testing** on board should be made, e.g. spot testing (ASTM D4740).
 - Test fuel alone
 - Familiar fuel alone
 - Test fuel vs familiar fuel: 50-50 (and 80-20 and 20-80)
 - Test fuel vs DMA: 50-50 (and 80-20 and 20-80)
- **Cylinder drain oil samples and analysis** from operation on familiar fuel and test fuel should be made.
- **Scavenge port inspections** are made to establish if the fuel has had any influence of the cylinder condition. It is important to match cylinder oil and feed rate with the fuel. Inspections should be made
 - 1. before start of test and
 - 2. after test.

The fuel system should be inspected, observed and paid attention to during the test fuel operation. If issues arise, appropriate action should be taken.

- Is the system working as it is supposed to?
- Separators (increased sludge?)
- Filters (blocking of filters?)
- Increased backflushing?
- Drains (blocked/free?)
- Sealings (especially for biofuel)
- Tanks
- Fuel pumps (general performance)

Engine performance evaluations are made to check if there are any major changes when running on the test fuel. It is advisable to do the testing under conditions as similar as possible. If there are no major differences between the engine's performance operating on the different fuels, the engine is doing well. Perform engine performance tests on familiar fuel, DMA and test fuel.

21. Biofuel

The use of biofuel in marine MAN B&W two-stroke engines has been limited so far due to the limited availability of biofuels and since biofuel was not included in ISO 8217 Petroleum Products – Fuels (class F) – Specifications of marine fuels. This is now changing gradually with ISO 8217:2017 6th edition opening up for certain biofuels. MAN B&W two-stroke engines are able to operate on all fuels within ISO 8217 limits.

MAN B&W stationary two-stroke engines have issued a paper regarding experience with biofuel, e.g. crude bio fuel, tallow, rapeseed oil (Stationary MAN B&W MC-S Engines for Biofuel Applications (5510-0098-00ppr Sep 2010)).

Biofuels are usually containing low amounts of sulphur. Hence, the general lubrication recommendations for operation on max. 0.50% S VLSFO apply. Cylinder condition should be monitored carefully and the fuel must be cleaned adequately.

Potential problems with biofuels are mainly long-term storage stability, increased risk of corrosion in the fuel system, and filter and sealing material



Fig. 53: Microbial growth in the fuel water interface. Note the thread-like substance which could easily block filters.

issues. Some biofuels are prone to attract water, which also increases the risk of microbial growth (Fig. 53) and corrosion. Water can be removed by a properly designed fuel system. It is important that the separators are operated and maintained. If free water is appearing in the fuel tanks, it is important to drain this water off. Removing the water will decrease the risk of microbial growth, sometime called “diesel pest”, and corrosion.

In case a microbial activity is suspected a planned process for dealing with it should be carried out. An example is given below:

1. Isolate the tanks and drain excess water
2. Seek expert guidance on the steps to take next
3. Draw samples from
 - a. the water fuel interface in tanks
 - b. the sludge
4. Drain tanks to remove the water
5. Contact a consultant / expert for next steps

MAN ES does not recommend that ships carry their own biocide chemicals, unless this is part of a planned treatment programme.

Ash content in the fuel and potential abrasive components such as silicates are factors to take into account. High ash content could present operational issues in the engine and in system after the engine. Phosphor levels should be kept as low as possible. Abrasive materials entering the engine will increase the wear of liners and piston rings, but the abrasive materials can often be removed if the fuel cleaning system is used adequately.

The flashpoint must be in accordance with the SOLAS requirement, minimum 60°C when the fuel is used in marine applications.

Close attention should be paid to the acid number (AN, method ASTM D664). Section from guiding biofuel specification (27-06-2017, 5755829-2):

- Acid number: max. 2.5 mg KOH/g
- For special applications and if the intention is to utilise fuels with AN higher than 2.5 mg KOH/g, there may be a need for changing the materials in the fuel injection system to anti-corrosive materials.
- Acid number: max 25 mg KOH/g, when special anti-corrosive materials are used in the fuel system.
- Strong acid number: max 0 mg KOH/g

ISO 8217:2017 6th ed.

There are many important changes in the 6th edition from 2017 compared to the frequently used 3rd edition from 2005. Two changes concerning biofuel are:

1. The scope has changed to include “hydrocarbons from synthetic or renewable sources, similar in composition to petroleum distillate fuels.” An example is hydrotreated vegetable oils (HVO).
2. New distillate marine grades, where up 7% of fatty acid methyl esters (FAME) are allowed.

FAME

FAME (fatty acid methyl esters) is often referred to as biodiesel and sometimes as biofuel. FAME is a biofuel, but biofuel can also be other types of molecules. Occasionally, marine fuels can contain FAME since diesel intended for the automotive market has found its way into the marine products. According to ISO 8217:2017, the FAME used for marine applications must meet

the requirements of EN 14214 or ASTM D6751 (please refer to ISO 8217:2017). FAME has good ignition and lubricity properties and blends of ordinary petroleum-based fuels (DM or RM) and FAME up to 7% should not impose any larger issues. However, there are some specific complications that need to be considered in order to ensure safe and reliable operation.

Before using FAME-containing fuels, it should be ensured that tanks, pipes, equipment and components match with the fuel in terms of materials and operational performance. It is recommended to check if the materials in gaskets and sealings are compatible with FAME. It is recommended that FAME is not in contact with equipment and parts made by materials such as bronze, brass, copper (Cu), lead (Pb), tin (Sn) and zinc (Zn). These may oxidize FAME and thereby create sediments (ref. ISO8217:2017 edition 6). Most components and equipment in ship systems are made by steel or stainless steel. Copper might be present in heat exchangers and bronze in valves.

Water content and acid number are the main concerns. Water is a concern in regard to microbial growth and corrosion, and acid number in regard to corrosion. Water should be removed as much as possible.

FAME molecules can fall apart and form organic acids which can give rise to corrosion in the fuel system. It is therefore important to measure the Acid Number (AN). DM grades usually have AN less than 0.5 mg KOH/g and RM grades usually have less than 2.5 mg KOH/g as according to ISO 8217.

The cold flow properties should be checked and the fuel should be heated to adequate temperatures.

CIMAC WG07 has issued guidelines concerning this topic: CIMAC WG07 Guideline to ISO8217:2017 6th edition and CIMAC WG07 Guideline to handling marine fuels with FAME.

Hydrotreated vegetable oil (HVO)

Hydrotreated oils from various renewable sources have started to appear on the marine fuel market. HVO consists mainly of paraffinic hydrocarbons and has a very low content of aromatics and does not contain any FAME (biodiesel). HVOs are often very similar in characteristics to DMA. The viscosity and density are often both found low. The energy content is high, and the oxygen which is present in the feed stock has been removed, leaving the carbon and hydrogen in the fuel. The resulting hydrocarbons are similar in composition to petroleum distillate fuels. HVO is claimed to be fully compatible with diesel fuels and DMA. According to literature, it behaves similarly to diesel fuel, which means that there should be no major issues with stability, water separation and microbiological growth if treated as DMA.

Please contact your MAN ES two-stroke representative if you are planning to use biofuels not complying with ISO 8217:2017 6th edition. Cases will be handled on a case-by-case basis.

22. Fuel not fit for purpose – fuels creating problems on board

From time to time, fuels which create issues and damage on board vessels appear on the marine market and it is usually very difficult to establish the root cause for these issues. We call these fuels “not fit for purpose”. The lack of definitive answers on why the issues and damage occur makes it difficult to give clear guidelines on what substances are clearly not acceptable in marine fuels as components in marine fuel are not clearly defined, and many different molecular species are found in marine fuel (CIMAC position paper, 2018 marine fuel incidents). This section provides advice on what to do when fuel related issues are expected or when they occur.

There is a risk of contamination when fuels are pumped and transported, and sometimes it may happen that fuels are made with cutter stocks (blend stocks) which are not suitable for marine fuel blending. Both of these can render a fuel not fit for purpose. Care should be taken if cutter stocks unknown to marine applications have been used to blend fuels intended for marine use and contamination should be minimised. If problems occur, it is very important that the chain of events be clearly documented in log-books and photographs. It is also important to

take fuel samples, so that it can be verified where the problem occurs or/ and if something has happened with the fuel from the point of supply to the engine inlet. Sampling and analyses are key factors if a root cause is to be established.

MARPOL and ISO 8217

MARPOL Annex VI, Regulation 18.3: Fuel quality states “fuel shall not include any added substance or chemical waste that: jeopardises the safety of ships or adversely affects the performance of the machinery”. Furthermore, according to clauses 1 and 5 in ISO 8217:2017 (E) there shall not be anything in the fuel that – after a conventional onboard treatment – can adversely affect the performance of the machinery.

Fuel sampling and fuel analysis

If a fuel is bunkered and problems or damages arise and it is suspected that the fuel is the main contributing factor to the issues, it is important to take fuel samples. Fig. 54 shows where to take samples if problems arise. By taking and analysing fuel samples from these

various positions, it is possible to track if any changes occur to the fuel when it is transferred from bunkering, before and after the separator and/or just before the engine inlet. As a minimum, an ISO 8217 analysis should be carried out. The same analysis should be performed on all samples. Other chemical analysis than the ones stated in ISO 8217 can also be made. If sludge and deposits are building up at various places, it is recommended to take samples and send for analysis.

If the fuel analysis indicates high content of material that should not be present in marine fuel or if the fuel is out of specification, the fuel supplier can be contacted. Clause 5 in ISO 8217 or MARPOL Annex IV, Regulation 18.3 may be applicable.

Keep in separate tank

A fuel that is not fit for purpose should be kept in a separate tank and should not be mixed with any other fuel. Mixing one good fuel with a “bad” fuel will increase the risk of ending up with one large batch of bad fuel. If mixing is the only option, the fuel not fit for purpose should be diluted to the highest extent possible.

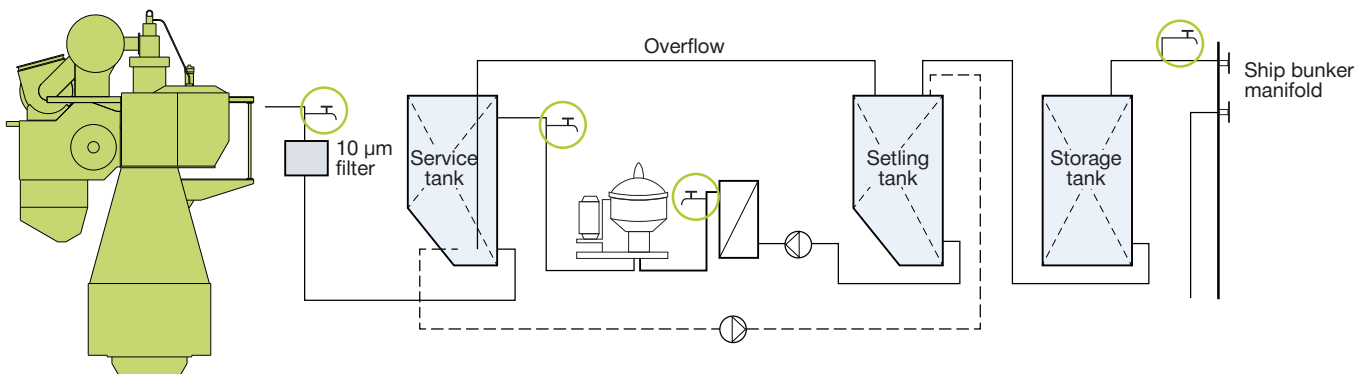

Fig. 54: Examples of fuel sampling positions.

If fuel not fit for purpose is used

If or when the fuel "not fit for purpose" is used, it is advisable to start using it in deep waters and well before entering high-risk areas (e.g. ports and other congested areas). If problems occur, STOP using the fuel immediately. It is advisable to carry a different fuel on board if it is necessary to make a switch. DMA (marine gas oil) could be a good option.

During the use of the fuel "not fit for purpose", the engine condition and the condition of the fuel system should be monitored carefully.

- Fuel index. In general, if the fuel index has increased by more than 10% at a given load compared to a load from shop test, the plunger and barrel are worn out. This is under the assumption that the suction valve is still functional.
- Monitor changes in the separators' and filters' performance. Consider increased sludge amounts, indication of filter clogging etc.
- Sometimes deposits in the fuel pumps can be removed and the pumps can be cleaned with DMA (marine gas oil) or another solvent, reassembled and used again.
- Make scavenge port inspections and monitor whether the condition changes.
- Documentation of the events is important.

23. References

MAN ES Service Letters (SL): <https://marine.man-es.com/two-stroke/service-letters>

MAN ES technical papers: <https://marine.man-es.com/two-stroke/technical-papers>

This paper: https://marine.man-es.com/docs/librariesprovider6/marketing-publications/catfines-paper/detailed_paper_0_50S_fuel.pdf

- ASTM D4740 – Standard test method for cleanliness and compatibility of residual fuels by spot test.
- CIMAC position paper, 2018 marine fuel incidents, CIMAC WG7 – Fuels, 10 November 2018
- CIMAC WG07 Guideline to ISO8217:2017 6th edition.
<http://www.cimac.com/publication-press/publications/index.html>
- CIMAC WG07 Guideline for shipowners and operators on managing distillate fuels up to 7.0% v/v FAME (biodiesel).
<http://www.cimac.com/publication-press/publications/index.html>
- ISO 8217:2017 Sixth edition. Petroleum products – Fuels (class F) – Specifications of marine fuels
- MAN ES paper “Cat fines. Impact on engine wear and how to reduce wear”.
- SL2014-587 Cylinder Lubrication Update. Always check for the newest!
- SL2014-593 Guidelines for Operation on Fuels with less than 0.10% Sulphur
- SL2017-638 Cleaning of Heavy Fuel Oil and Maximum 0.10% S Fuels – How to remove cat fines
- SL2018-659 Cermet-Coated Piston Rings for Operation on Low-Sulphur Fuels (0.50% S or lower)
- SL2019-670 Operation on fuels with maximum 0.50% sulphur
- Stationary MAN B&W MC-S Engines for Biofuel Applications (5510- 0098-00ppr Sept. 2010)
- SL2019-671 Cylinder lubrication update for 0 to 0.50% sulphur fuels.
- SL2019-674 Fuel Tank Cleaning
- Fuel 2020 – Are you ready for the 0.50% sulphur fuel cap?, Paper no: 374, CIMAC Congress 2019, MAN Energy Solutions: D. Jacobsen, J. Svensson, J. Sjöholm, K. Aabo, H. Andersson
- IP541:2015 – Determination of ignition and combustion characteristics of residual fuels constant volume combustion chamber method.

All data provided in this document is non-binding. This data serves informational purposes only and is not guaranteed in any way. Depending on the subsequent specific individual projects, the relevant data may be subject to changes and will be assessed and determined individually for each project. This will depend on the particular characteristics of each individual project, especially specific site and operational conditions.